

Top Hanging Bracket Mounting
Installation des supports d'accrochage du haut
Montaje de los soportes de suspensión superiores

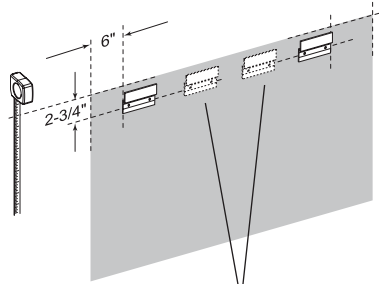

Note: 2 additional top hanging brackets included with boards 5' x 3' and larger. Align with built-in brackets on upper board frame to mark position.

Remarque : 2 supports d'accrochage supplémentaires pour le haut sont compris avec les tableaux de 152 cm x 91 cm (5 pi x 3 pi) et de plus grande dimension. Aligner les supports intégrés sur le cadre du haut du tableau pour marquer la position.

Nota: Se incluyen 2 soportes de suspensión superiores adicionales con los tableros de 150 x 90 cm (5 x 3 pies) y más grandes. Alinéelos con los soportes incorporados del borde superior del tablero para marcar la posición.

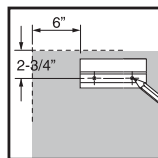

FIG. A

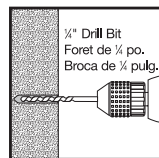

FIG. B

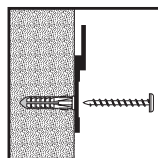

FIG. C

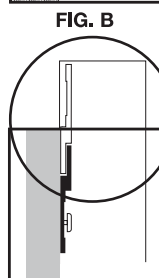

FIG. D

Side view with brackets engaged.
 Vue latérale montrant les supports engagés.
 Vista lateral con los soportes enganchados.

Bottom "L" Bracket Mounting
Installation des supports en équerre du bas
Montaje de los soportes inferiores en "L"

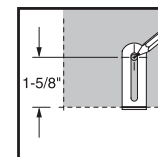
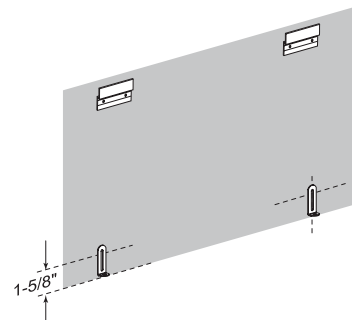

FIG. E

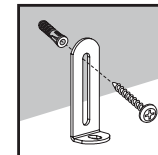

FIG. F

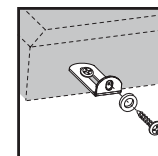

FIG. G

Attaching Showcase Lock
(Sliding Door Bulletin Boards Only)

Installation de la serrure de vitrine
(Tableaux d'affichage à porte coulissante seulement)

Cómo colocar el cerrojo
(Deslizando solo la puerta corrediza)

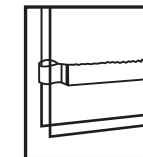

FIG. H

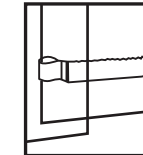

FIG. I

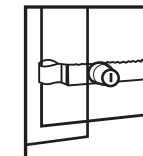
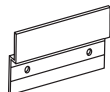

FIG. J

Parts List

Liste des pièces

Lista de piezas



- **Hanging brackets –**
 (2) for 4' x 3' boards or smaller
 (4) for 5' x 3' boards or larger
- **Supports de suspension –**
 (2) pour les tableaux de 122 cm x 91 cm
 (4 pi x 3 pi) ou de moindre dimension
 (4) pour les tableaux de 152 cm x 91 cm
 (5 pi x 3 pi) ou de plus grande dimension
- **Soportes de suspensión –**
 (2) para tableros de 122 x 91cm
 (4 x 3 pies) o mas pequeños
 (4) para tableros de 152 x 91cm
 (5 x 3 pies) o mas grandes

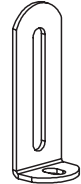

- **"L" brackets (2)**
- **Supports en équerre (2)**
- **Soportes en "L" (2)**



- **Drywall anchors –**
 (6) for 4' x 3' boards or smaller
 (10) for 5' x 3' boards or larger
- **Chevilles d'ancrage pour cloisons sèches –**
 (6) pour les tableaux de 122 cm x 91 cm
 (4 pi x 3 pi) ou de moindre dimension
 (10) pour les tableaux de 152 cm x 91 cm
 (5 pi x 3 pi) ou de plus grande dimension
- **Tarugos de anclaje para muro seco –**
 (6) para tableros de 120 x 90 cm
 (4 x 3 pies) o más pequeños
 (10) para tableros de 150 x 90 cm
 (5 x 3 pies) o más grandes



- **1/4" screws –**
 (6) for 4' x 3' boards or smaller
 (10) for 5' x 3' boards or larger
- **Vis 1/4 po –**
 (6) pour les tableaux de 122 cm x 91 cm
 (4 pi x 3 pi) ou de moindre dimension
 (10) pour les tableaux de 152 cm x 91 cm
 (5 pi x 3 pi) ou de plus grande dimension
- **Tornillos de 1 1/4" –**
 (6) para tableros de 120 x 90 cm
 (4 x 3 pies) o más pequeños
 (10) para tableros de 150 x 90 cm
 (5 x 3 pies) o más grandes



- **1/4" screws & washers (2)**
- **Vis 1/4 po et rondelles (2)**
- **Tornillos de 1/4 pulg. y arandelas (2)**

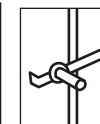

- **Lock assembly**
 (1 for sliding door board only)
- **Serrure**
 (1 pour les tableaux à porte coulissante seulement)
- **Conjunto de cerradura**
 (1 para el tablero con puerta corrediza únicamente)

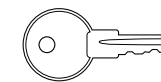

- **Keys (2)**
- **Clés (2)**
- **Llaves (2)**

Top Hanging Bracket Mounting

1. Determine board location.
2. Position top hanging brackets 6" from outside edge of board with bracket holes 2³/₄" from top of board. **(FIG. A)**
3. Mark wall at centers of bracket holes.
4. Drill holes for each hanger in marked locations using a 1/4" drill bit. **(FIG. B)**
5. Insert wall anchors into holes flush with the wall.
6. Insert 1 1/4" screws through hanging brackets into the wall anchors. Tighten firmly. **(FIG. C)**
7. Lower board onto the top hanging brackets so built-in brackets on upper board frame are engaged. **(FIG. D)**

Bottom "L" Bracket Mounting

1. With board hanging on top brackets, align "L" brackets with pre-drilled holes (located on bottom of frame) and mark position.
2. Remove board and mark wall 1⁵/₈" from bottom of "L" brackets. **(FIG. E)**

3. Drill holes in marked locations using a 1/4" drill bit. Insert wall anchors into holes flush with wall.
4. Insert 1/4" screws through "L" brackets into wall anchors. Secure, but don't overtighten. **(FIG. F)**
5. Hang board and insert 1/4" screw and washer through each "L" bracket into pre-drilled hole in frame. Tighten firmly. **(FIG. G)**

Attaching Showcase Lock (Sliding Door Bulletin Boards Only)

1. Position notched bar on inside door **(FIG. H)** and tighten screw. Note: On glass doors, do not over tighten.
2. Slide outside door closed **(FIG. I)**.
3. Slide lock over notched bar (flat side against outside door edge) **(FIG. J)**. Showcase locks without key. Key required to unlock.



ACCO Brands (Returns Center)
 101 Bolton Ave 9E
 Booneville, MS 38829 USA
 Tel: 800-541-0094

www.acco.com

Quartet is a registered trademark of General Binding Corporation. ACCO name and design are registered trademarks of ACCO Brands. ©2013 ACCO Brands Corporation. All rights reserved. Patent Pending.