

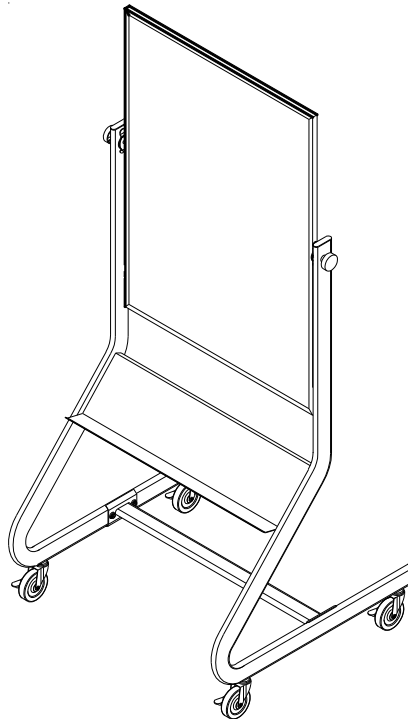

Best-Rite™









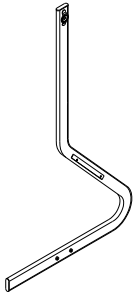
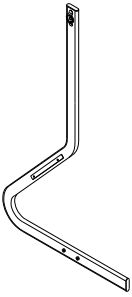

Euro Reversible

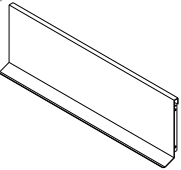
667RU-667RG

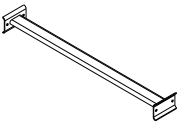

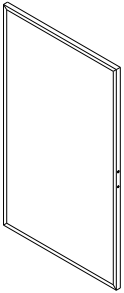
Assembly Instructions

Euro Reversible

Part	Drawing	Description	Qty	Part	Drawing	Description	Qty
P-1		Right Leg	1 EA	Hardware List			
P-2		Left Leg	1 EA	A		Socket Screw 6*12mm	8 EA
P-3		Tray	1 EA	B		Caster Lock Washer	4 EA
P-4		Cross bar	1 EA	C		Flange	2 EA
P-5		Framed board	1 EA	D		Knob	2 EA
				E		4" Locking Caster	4 EA
				F		Allen Wrench	1 EA
				G		Caster Wrench	1 EA

Should you require assistance during assembly, please call our Customer Service Department Monday - Friday 8 a.m. - 5 p.m. Central Standard Time Toll-Free Customer Service 1-800-749-2258

Euro Reversible Assembly Diagram

READ THROUGH INSTRUCTIONS FROM BEGINNING TO END BEFORE STARTING TO ASSEMBLE UNIT.

1. To Assemble:

Identify and Separate all the Parts and Hardware.

2. Install Cross bar (P-4) to the Legs (P-1) and (P-2) by using Socket Screws (A). Tighten with Allen Wrench (F). See illustration # 1.

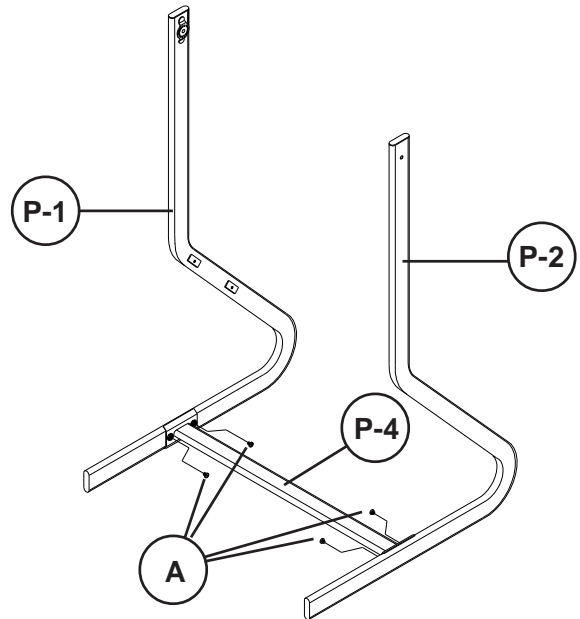

Illustration # 1

3. Insert locking casters (E) with Caster Lock Washer (B) to the bottom of each Legs (P-1) and (P-2) and tighten using Caster Wrench(G). See illustration #2.

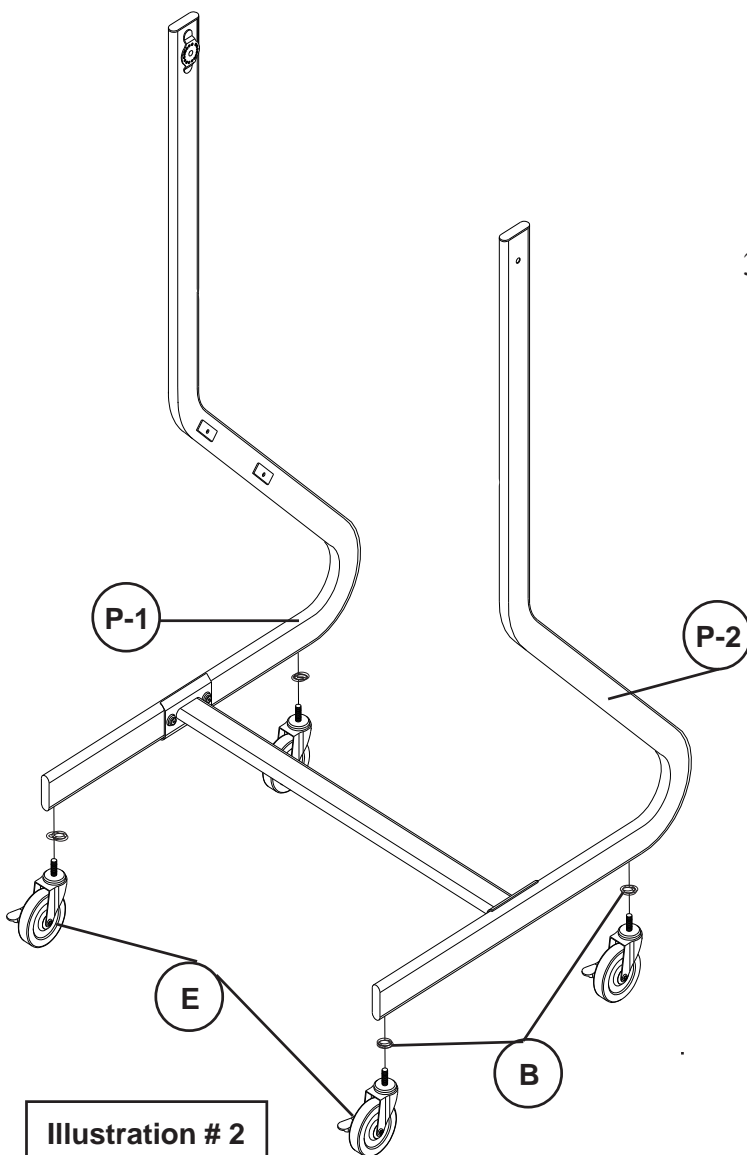

Illustration # 2

Missing Parts or UPS Damaged Parts
For Your Convenience you can
EMAIL us at
support@moorecoinc.com
24HOURS 7 DAYS A WEEK

Illustration # 3

- Detach 2 screws from each side of Framed Board (P-5) with Phillips Screwdriver as shown in illustration # 3.

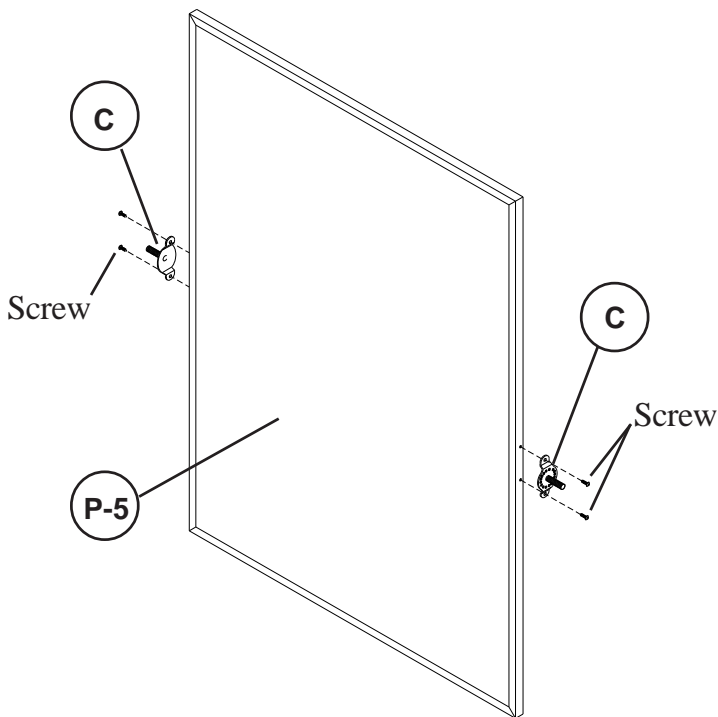
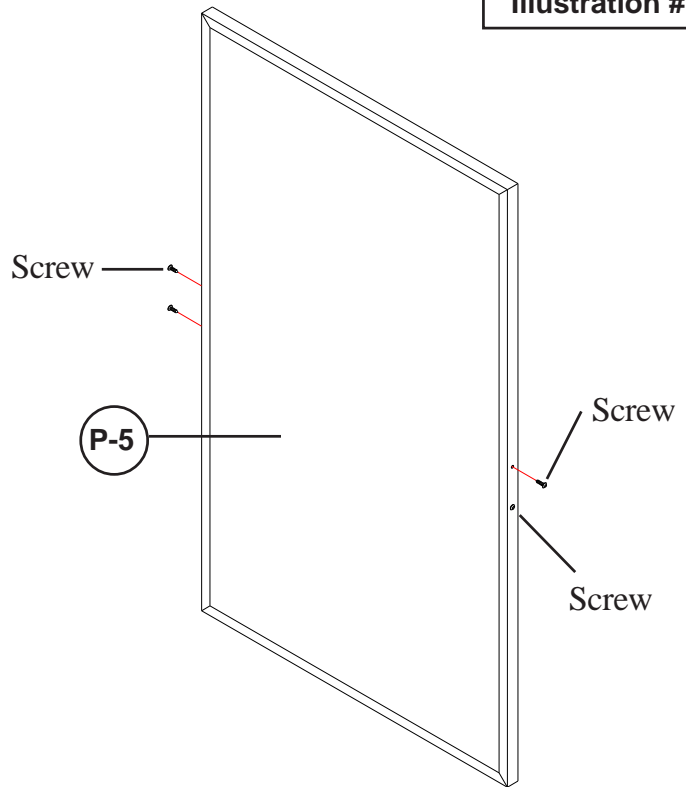

Illustration # 4

- Install Flange (C) on each side of the board by using the same 4 screws from step 5 and tighten with Phillips Screwdriver. See illustration # 4.

Do not use unless all screws are tight. At least every six months, check all screws to be sure they are tight. If parts are missing, broken, damaged, or worn, stop use of the product until repairs are made by your dealer using factory authorized parts.

Euro Reversible

6. Separate the Legs (P-1) and (P-2) slightly in order to insert the flange bolts through the flanges on legs. Fasten the Knobs (D) to secure the board in place. See illustration # 5.

Illustration # 5

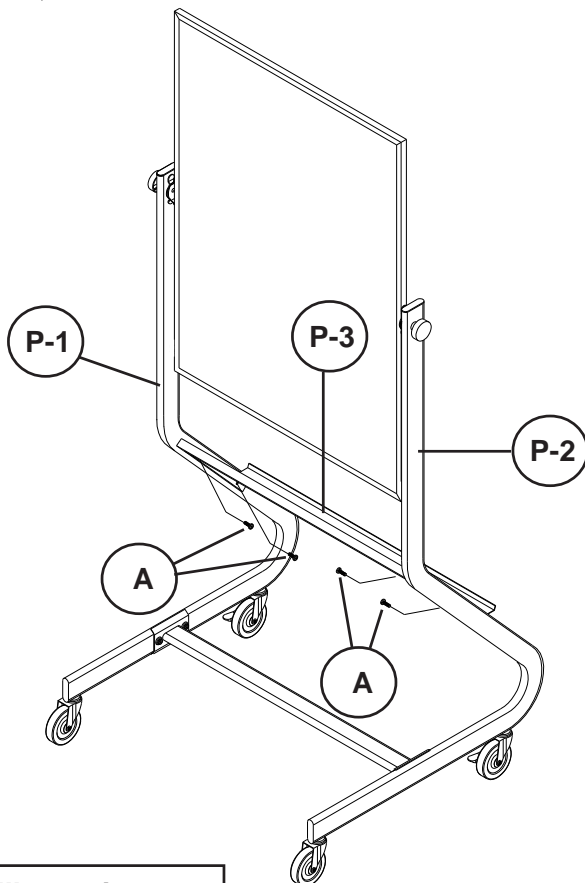
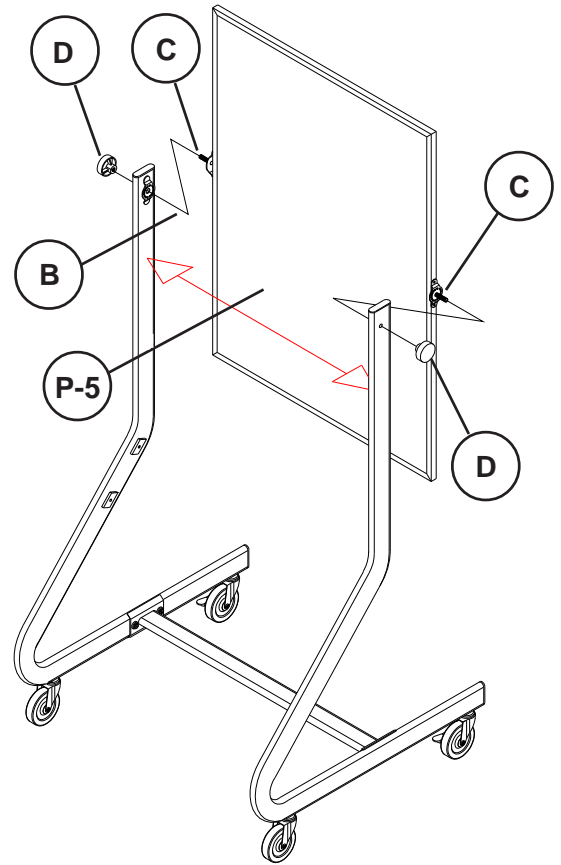

Illustration # 6

7. Assemble Tray (P-3) to the legs with using Socket Screws (A) and tighten with Allen Wrench (F). See illustration # 6.

Euro Reversible 667

