

# Akiles ProLam 6 Roller Pouch Laminator

## Instruction Manual



Provided By

**MyBinding**.com®  
*When Image Matters.*

# 6R PROFESSIONAL LAMINATOR

## OPERATION MANUAL

*Please read this manual carefully before operation*

---



## CONGRATULATIONS

Thank you for purchasing and using our laminator. You have purchased the finest laminator available in its service class. It was designed and manufactured to provide you with the utmost in utility. As with any device that combines power and movement in its use, there are dangers if improperly used. At the same time, there are easier and faster ways for getting the job done if certain precautions are taken first. Please read this manual carefully. It contains useful ideas in obtaining the most efficient operation from your laminator and safety procedures you need to know before beginning use. When you follow our guidelines for operation, your laminator will give you many years of satisfying service. Thank you for choosing our product. You will be glad you have one working for you.

### CONTENTS

CONGRATULATIONS .....	1
SAFETY PRECAUTIONS .....	2
STRUCTURE AND CONTROL PANEL .....	4
FUNCTIONS OF DIGITAL DISPLAY AND CONTROL PANEL .....	5
OPERATION INSTRUCTIONS	
Hot laminating .....	7
Cold laminating .....	8
MAINTENANCE AND SERVICE .....	9
SPECIFICATIONS .....	10

## SPECIFICATION

<b>Model</b>	<b>330-6R</b>	<b>450-6R</b>
<b>Max. Laminating width</b>	<b>330 mm</b>	<b>450 mm</b>
<b>Max. Laminating thickness</b>	<b>1 mm</b>	
<b>Laminating speed</b>	<b>400 - 2100 mm/min.</b>	
<b>Hot Laminating Temp.</b>	<b>51 - 160 °C</b>	
<b>Cold Laminating Temp.</b>	<b>0 - 50 °C</b>	
<b>Warming-up time</b>	<b>5 Minutes</b>	
<b>Control system</b>	<b>8 bit micro-processor</b>	
<b>Display system</b>	<b>Digital display</b>	
<b>Cooling system</b>	<b>DC fan</b>	
<b>Driving motor</b>	<b>DC gear speed adjustable motor</b>	
<b>No. of rollers</b>	<b>6 pcs (4 pcs for heating)</b>	
<b>Power supply</b>	<b>AC 100, 110, 220 - 240V / 50Hz, 60Hz</b>	
<b>Power consumption</b>	<b>1150W</b>	<b>1550W</b>
<b>Dimension (L×W×H)</b>	<b>550 × 295 × 135 mm</b>	<b>670 × 295 × 135 mm</b>
<b>Weight</b>	<b>17 kg</b>	<b>20 kg</b>

# MAINTENACE AND SERVICE

## Maintenance

1. This machine is electrical product, it can not be sprayed by water directly.
2. Before maintenance, disconnect the power supply firstly.
3. Do not use gasoline, thinner or metal brush to clean the machine.
4. Use soft cloth to clean the dust. If the dust is thick, scrub it away with neutral soap water or detergent firstly, then clean it with dry cloth.

## Service



















**If you need repairing service, please inspect the followings in advance:**

- The plug is loose from the power socket.
- The power supply is cut off.
- The fuse in the machine is melt. The fuse is installed on the back of the machine.

















**If repairing service required, please provide:**

- ◆ Type of trouble
- ◆ Model of machine
- ◆ Serial number of machine

# SAFETY PRECAUTIONS

 <b>WARNING</b>	
 Please do not use broken, aging or self-made electrical wire. Please do not immoderately draw, twist or enlance the electrical wire, to avoid the fire or electric shock.	
 If the supply cord is damaged, it must be replaced by the manufacturer or our service agent or a similar qualified person in order to avoid a hazard.	
 Please do not use the power supply that is not in accordance with the rated voltage, to avoid the fire or electric shock.	
 <b>NO DISJOINT</b>	 Don't disjoint, modify and repair the machine yourself.
 <b>ENTANGLEMENT CAUTION</b>	 Avoid necktie or necklace entangled. In case some articles entangled, press the REVERSE button right away; if not workable, cut off the power supply at once, and contact your dealer for settlement.
 <b>ELECTRIC SHOCK CAUTION</b>	 Do not open the cover, electric shock inside.  Do not make the electrical wire or plug or the machine bedewed by water or other liquids.  Do not operate the machine with wet hand.  Do not make the machine pressing on the electrical wire.  Do cut off the power supply while moving the machine.  Do not operate the machine with the cover open.
 <b>HIGH TEMPERATURE CAUTION</b>	 Do not put articles on the laminator while it is working, so that to disperse the heat.  Do not insert the easy-burnt or easy-softened material into the machine, in case they are melt and give rise to smoke.  Do not touch the cover, rubber roller and heating parts while the machine is working, in case heat injury.

## SAFETY PRECAUTIONS

 CAUTION	
<b>WORKING PLACE</b>	<ul style="list-style-type: none"> <li> This machine should be put at the dry and clean place, do not put it at the damp place or near the exit of cooling appliances.</li> <li> This machine should be put on the horizontal and firm place. In front and rear of the machine, there should be sufficient place for the document in and out.</li> <li> Do not put any articles on the machine.</li> </ul>
<b>POUCH FILM</b>	<ul style="list-style-type: none"> <li> Please use good quality pouch film, in order to show the lamination effect, and avoid the entanglement.</li> <li> The length and width of the pouch film should be 3-5mm larger than the document to be laminated.</li> </ul>
<b>OBJECT</b>	<ul style="list-style-type: none"> <li> The laminating machine use the hot press technology, do not use the following objects in case laminating failure or pouch film entangle.               <ul style="list-style-type: none"> <li>※1. Easy-burnt material, easy-softened material.</li> <li>2. The width of document is bigger than the distance between the two convex lines on the input board..</li> <li>3. The thickness of document is bigger than 1mm.</li> <li>※4. Single side pouch film (PVC film).</li> <li>※5. The document printed by heat-sensitive paper, or any articles that can be faded or transformed after heating.</li> <li>6. Any articles that have drape, breakage, dampness or deformation before laminating.</li> <li>7. Coin or any other hard articles.</li> </ul> </li> <li>※<i>means exception while cold laminating operation.</i></li> </ul>
<b>MACHINE OPERATION</b>	<ul style="list-style-type: none"> <li> Do not turn to other usages except the usage range stated in this operation manual.</li> <li> Do not use the machine outside the room. Before leaving, please cut off the power supply if the operation is over.</li> <li> If there are any problems on the machine, please do not use it, send it to the dealer for repairing.</li> </ul>
 ADVICES	
<ul style="list-style-type: none"> <li> While operating the machine, mind the children nearby, in case any suddenness.</li> <li> Do not suspend the electrical wire on the table or cabinet or any other places that the children can touch, or place easy stumble persons.</li> <li> Using the accessory that not recommended or sold by the manufacturer, might cause damage on the machine.</li> <li> The photo or document once is laminated, it will become permanent and will not be taken apart.</li> <li> Please do not laminate the collected rare articles, or some articles might be taken out in the future.</li> </ul>	

## OPERATING INSTRUCTION

### 3) Temp adjustment

There are Temp control keys on the control panel. Different pouch film, different document, different room Temp, should have different working Temp. If the laminated document is not clear, it might because the Temp is low, increase the Temp by 5°C, then laminate it again, until a perfect laminated document appears. If the Temp is too high, the laminated document will be corrugation, if so, decrease the Temp until get the perfect laminated document.

**Note: If the best working Temp is not clear, set Temp 80°C and speed 3 first, then make adjustment according to the laminating result. Do not set the Temp more than 120°C, in case the laminating film is melt.**

### 3. COLD LAMINATING

#### 1) Preparation

Turn on the power switch, the display turns light. **The Temp must be set to less than 50°C.** When cold laminating, the suggested Temp is below 40°C, the suggested speed is speed 1-4.

#### 2) PVC film

Take off a little glue side of the PVC film from the under cover paper.

**Note: Do not uncover too much PVC film from the under cover paper, or remove the PVC film from the under cover paper entirely, this will make the PVC film useless.**

#### 3) Cold laminating

Put the glue side of PVC film on the front of document parallel, make the glued end in front, place it between the two convex line on the input board. Slightly place the document at the middle of inlet, keep the document in alignment with the inlet. Then the document will be cold laminated. Steadily remove the under cover paper from the PVC film in opposite direction. (Shown as FIGURE 2). Now a perfect cold laminated document appear on the output board.

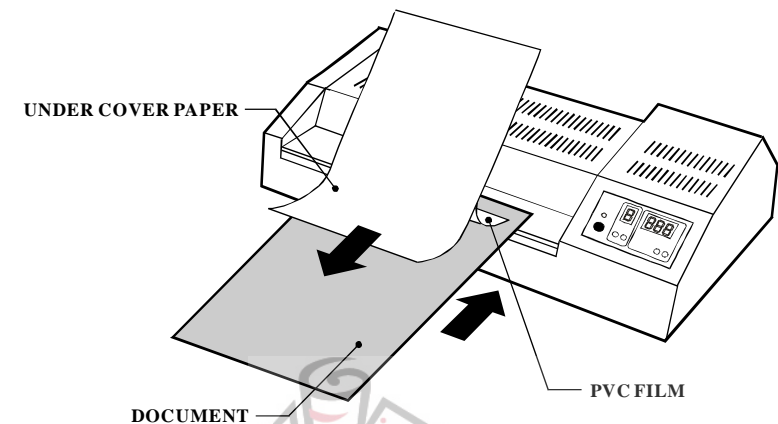
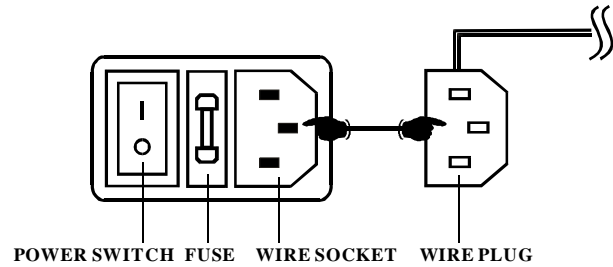

FIGURE 2

# OPERATING INSTRUCTION

## 1. CONNECTING THE POWER SOURCE

- 1) Checking the rated voltage on the machine, to insure it conform to the powersource. Also, checking the plug to insure it conform to the socket.
- 2) If the electric wire does not connect with the machine, connect it with the wire socket on the back of machine.



- 3) Insert the plug into the power socket that is grounding correct.
- 4) Turn on the power switch, the display light, it indicates the power is connected.

## 2. HOT LAMINATING

- 1) Preparation  
Turn on the power switch, the display turns light. Set the Temp to more than 60°C, the machine begin to heat. When the Temp increase to the setting Temp, the constant Temp lamp turns light. Waiting for another 2 minutes, the Temp get stable, then you can begin laminating. During the working period, the Temp constant lamp will be light, it indicates that the machine is ready to laminate.
- 2) Hot laminating  
Put the paper into the pouch film, and make the sealed end of pouch in front, then insert it into the machine. (Shown as FIGURE 1). If put other sides in front, it will bring fold or the machine is blocked. If the paper is blocked, press the Reverse button, the motor will reverse, and the paper will withdraw. When inserting the pouch film into the machine, insure it is between the two convex lines on the input board. Now, the whole laminating operation is finished, a perfect laminated card appear on the output board.

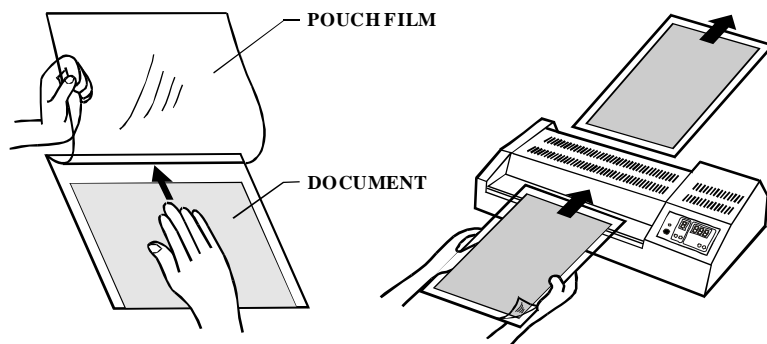
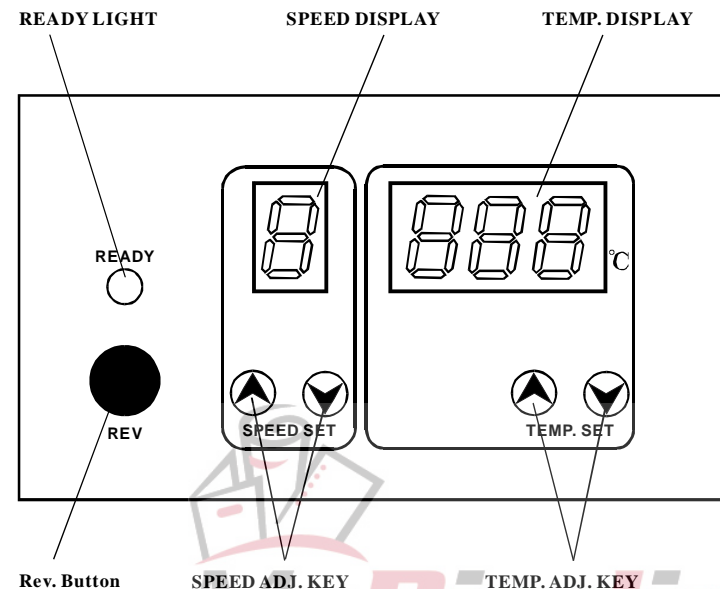
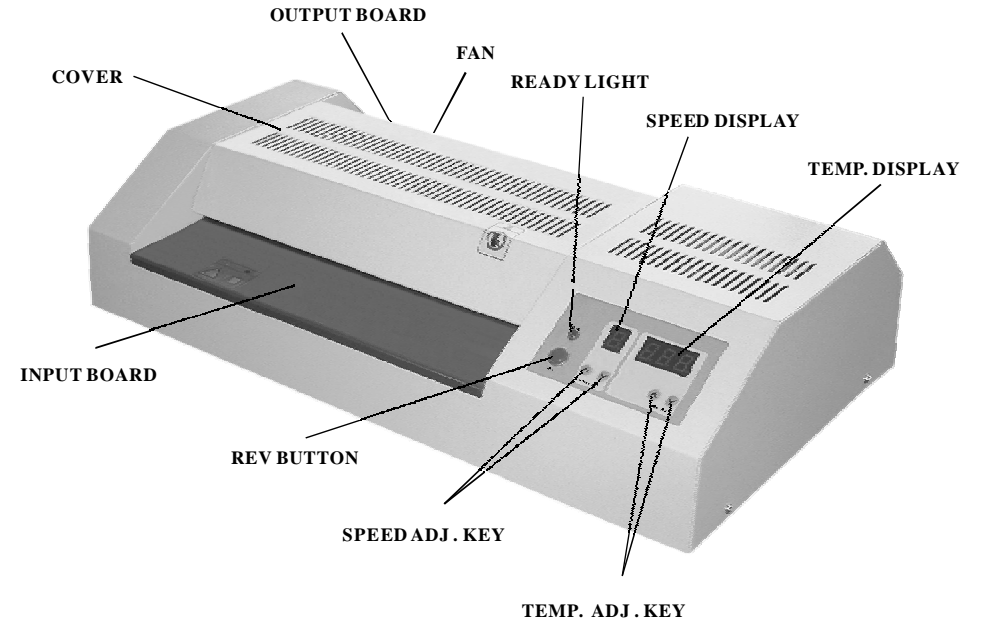

FIGURE 1

# STRUCTURE AND CONTROL PANEL



# FUNCTIONS OF DIGITAL DISPLAY AND CONTROL PANEL

## 1. Digital display and Functions

### 1) Sleeping function

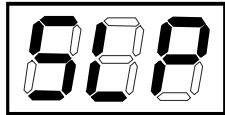

SLP

A) When the machine does not laminate the document for about 15 minutes continuously, the machine will enter into sleeping function automatically.

**Note:** I) While entering into sleeping function, the machine cut off heating power supply automatically.

II) Temp display shows SLP and flash .

III) After the roller Temp decrease below 60°C , the motor will be turned off automatically.

B) Waking up the sleeping function

I) Press any key

II) Restart the power supply

### 2) Protecting function of Temp sensor's open circuit and short circuit



OPN

When the sensor is in open circuit, shows OPN

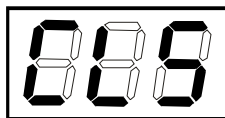

CLS

When the sensor is in short circuit, shows CLS

### 3) Over-heat protecting function

When the roller Temp over 160°C, the over-heat protecting circuit will cut off the heating power supply automatically.

### 4) Automatic memory function

After pressing the control button, within 3 seconds, the machine can automatically save the setting data (speed, temperature, running mode), these data can be recovered for next operation.

**Note: Do not switch off the machine within 3 seconds after pressing the control button, in case the setting data might damaged.**

# FUNCTIONS OF DIGITAL DISPLAY AND CONTROL PANEL

## 2. Button function of control panel

### 1) Temperature control



UP DOWN

TEMP. ADJ. KEY

A) These can be used for increasing or decreasing Temp manually. The Temp can be increased or decreased by unit to 1°C when these keys are pressed. Pressing the key, the Temp will be increased or decreased continuously until you loose the key.

B) The range of Temp that can be adjusted manually is 0°C--160°C.

C) When the Temp over 160°C , the over-heat protecting system will run automatically.

D) When pressing the Temp adj. key, it indicates the setting Temp. When loosing the key for 3 seconds, it indicates the present Temp automatically.

E) When the Temp reach the setting Temp, the Temp ready lamp lights.

### 2) Speed control



UP DOWN

SPEED ADJ. KEY

SPEED 1: SLOW

SPEED 9: FAST

A) These can be used for increasing or decreasing speed manually. The speed can be increased or decreased by unit to 1 speed when these keys are pressed.

B) The range of speed that can be adjusted manually is speed 1 to speed 9.

C) Wait for heating

a) If the setting Temp is less than 90°C, when the actual Temp of the roller increase to 30°C below the setting Temp, the motor start.

For example, if the setting Temp is 85°C , when the actual Temp of the roller increase to less than 55°C , the motor will not run. Once the actual Temp reach to 56°C , the motor start.

b) If the setting Temp is more than 90°C , when the actual Temp of the roller increase to 60°C , the motor start.

This will protect the machine.

### 3) REV control Button



REV



**Use for reverse operation in emergency.**

**Use for remove articles that inserted by mistake.**



When Image Matters.