

***Akiles CoilMac EPI
Heavy Duty Electric Coil
Punch & Inserter***

Instruction Manual



Provided by

MyBinding.com
When Image Matters.

Call Us at 1-800-944-4573

CoilMac-EPI OPERATIONAL MANUAL

INTRODUCTION

CONGRATULATIONS ON THE PURCHASE OF YOUR NEW *CoilMac-EPI*, A PROFESSIONAL AND HEAVY-DUTY COIL PUNCH AND BINDING MACHINE. YOUR *CoilMac-EPI* WAS CAREFULLY DESIGNED WITH A FULL RANGE OF FUNCTIONS AND PREMIUM QUALITY COMPONENTS TO GUARANTEE AN EFFORTLESS AND PROFESSIONAL BIND, AS WELL AS MANY YEARS OF TROUBLE-FREE SERVICE.

IMPORTANT

WE RECOMMEND THAT YOU TAKE A FEW MINUTES TO FAMILIARIZE YOURSELF WITH THE FUNCTIONS OF YOUR NEW *CoilMac-EPI*. YOU WILL FIND THAT WITH JUST A LITTLE PRACTICE, ANYONE CAN ACHIEVE PROFESSIONAL RESULTS.

FEATURES

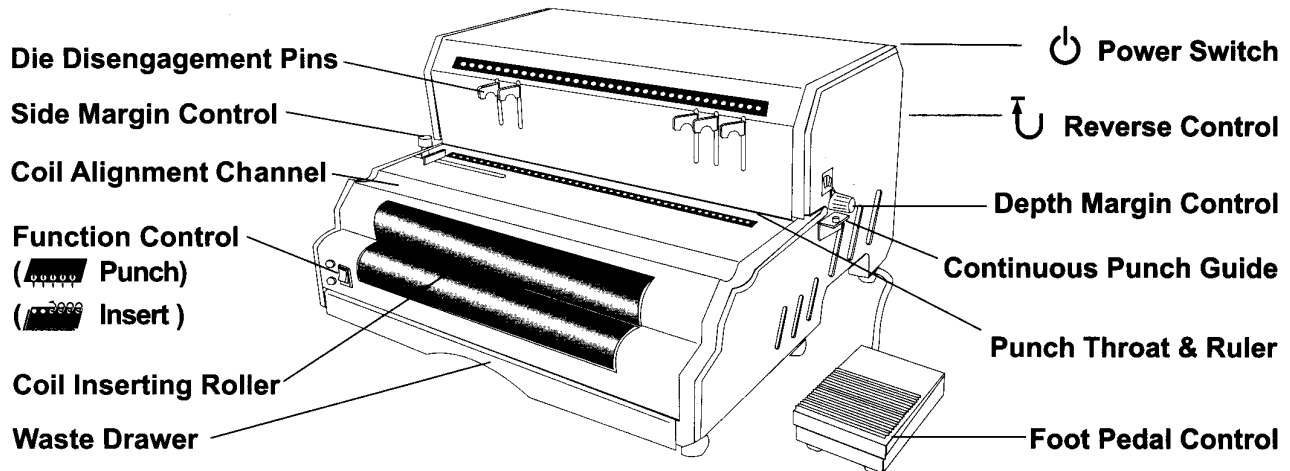

ASSEMBLY & SAFETY INSTRUCTIONS

1. Place your new *CoilMac-EPI* on top of a sturdy working table. **See picture 1**
2. Plug the power cord and foot pedal cord to the back of machine **See picture 2**
3. Turn on Power Switch. Recommended: Switch the Function Control between PUNCH & INSERT and press foot pedal to test the electric punch and coil inserter. **See picture 3.**

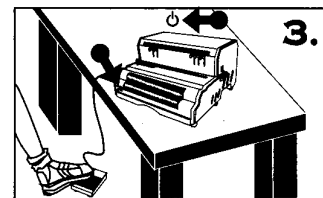
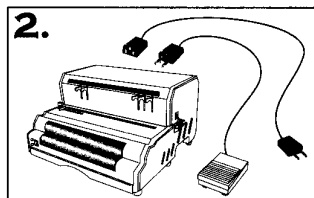
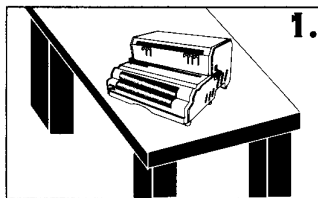

4. Keep fingers, hair, jewelry, necktie and any loose clothing or objects away from roller, as they may be accidentally pulled into the roller.
5. Do not allow children to operate the machine. The *CoilMac - EPI* is not a toy.
6. Always turn switch-off and place foot pedal out of reach when machine is not in use.
7. To reduce the risk of electric shock, never operate the *CoilMac-EPI* near water.
8. Do not use the *CoilMac-EPI* if power cord is damaged.
9. Do not allow the electric cord to be in contact with hot surfaces.
10. In case of malfunction, return the unit to your distributor for service. This equipment does not contain any part that can be serviced by the consumer or operator.



SET-UP

1. Use Coil Size Guide to determine the correct:

- ☞ Depth Margin
- ☞ Coil Diameter

See Picture 1

2. To adjust the correct Punching Margin, press and rotate the Depth Margin Control. **See Picture 2**

3. (OPTIONAL) You may use the Coil Diameter Selector to determine or double check that you are using the correct coil diameter for your document. **See Picture 3**

HINT

To properly adjust the depth margin, press and rotate the Depth Margin Control at the same time. Release it upon reaching the desired position. **The Depth Margin Control button must bounce-back upon release. If it does not bounce-back, rotate it slightly back and forth until it does so. See picture 4**

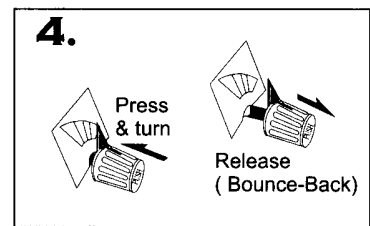
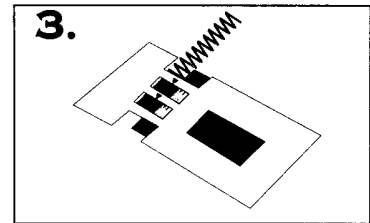
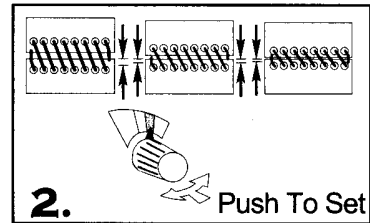
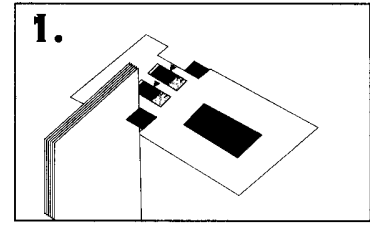

PUNCHING

1. Use the Punch Throat Ruler and Side Margin Control to center the punching of your document. **See Picture 1 & 2.** **HINT:** Insert a sheet and make sure you disengage any hole that is left partially exposed on the Punch Throat Ruler. Failing to do so, will leave a partially perforated hole at the edge of your document.

2. Make sure the Function Control is set on PUNCH and the LED Indicator of  is on. Insert sheets and press foot pedal to punch. **See picture 3**

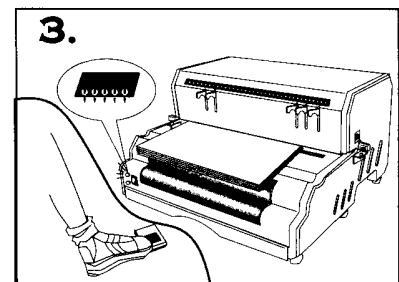
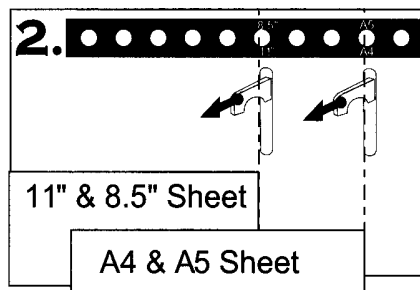
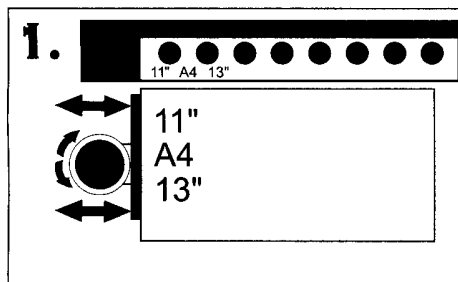

REMARKS:

- a). When using your **CoilMac-EPI** for the first time, punch a few waste sheets. This will clean-off any excess oil on the punching dies.
- b) Maximum single punching capacity: 23 sheets (20 lbs paper)
- c) Recommended number of sheets per punch (for maximum equipment durability): 15 sheets (20 lbs paper)
- d) Empty the Waste Drawer from time to time. Overfilled Waste Drawer may cause machine to malfunction.

IN CASE OF PAPER JAM

The punching action will automatically stop in case the punch sheets are overloaded or too heavy. When this occurs, simply press the Reverse Button in the back of the machine repeatedly, until all the punching dies return to their original, home position. Now you can pull out some of the sheets and re-start the punching action by pressing the Foot Pedal again.

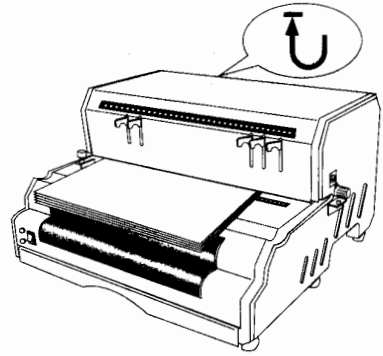

FOR PUNCHING DOCUMENT 14" (356MM) OR LARGER

1. Align Sheets as indicated on Punch Throat Ruler. Make sure all Die Disengagement Pins are pushed in.
2. Insert sheets and press Foot Pedal to punch. **See Picture 1**
3. Remove sheets and flip them over as illustrated. **See Picture 2.**
4. Insert sheet from right-hand-side. Press Foot Pedal to Punch. **See picture 3.**

IMPORTANT: Document must be inserted in such a way as to place one of the already perforated holes onto the **Continuous Punch Guide**. Make sure that the last hole (Document edge), if partially covered by the Punch Throat & Ruler, is aligned to a disengaged die, otherwise your document will be left partially perforated.

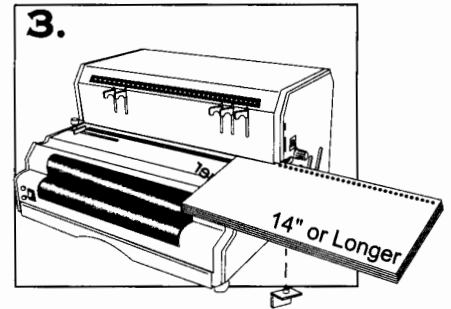
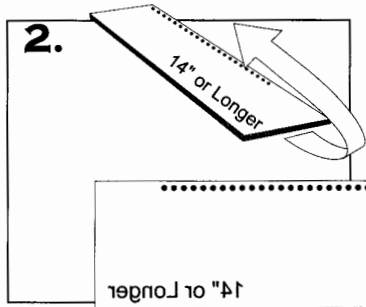
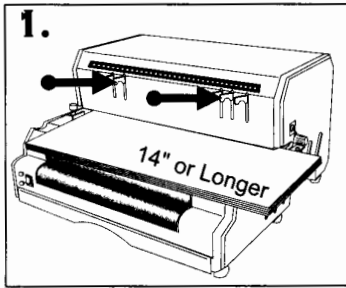

COIL INSERTING (BINDING)

1. Make sure the Function Control is set on INSERT and the LED Indicator of  is on. Align punched document on Alignment Channel. **See picture 1**
2. Place document on top of machine or table and insert the coil into the first 4 to 5 holes. **See picture 2**
3. Hold document evenly against the roller (coil must touch the roller slightly). **See picture 3**
4. Press foot pedal. The coil will automatically move forward inserting itself into the holes. **See picture 3**
5. After the coil is inserted completely to the document, IMMEDIATELY pull document away from the roller AND/OR let go of the foot pedal. REMARK: If coil is over-inserted, simply flip the document over and proceed with STEP 3 again.
6. Use crimpers to cut & crimp the excess coil. Make sure you crimp both ends. This procedure will prevent the document from unbinding itself. **See picture 4**

