

Morgana DigiBook 150 Automatic PUR Perfect Binding Machine

Instruction Manual



Provided by

MyBinding.com

When Image Matters.

Call Us at 1-800-944-4573



DigiBook 150r1

Operators Manual



MyBinding.com
5500 NE Moore Court
Hillsboro, OR 97124
Toll Free: 1-800-944-4573
Local: 503-640-5920

Rev. 1.00-C
K.G.S. srl

Summary

1	INTRODUCTION	4
1.1	CE MARK	5
1.2	SAFETY SYMBOLS	6
1.3	SYMBOLS OF PROHIBITION AND OBLIGATORINESS	7
1.4	THE SAFETY DURING THE USE OF THE MACHINE	8
1.4.1	General	8
1.4.2	Safety warnings	8
1.5	SAFETY CLOTHING	9
1.6	INSTALLATION OF ELECTRICAL CABLES AND HOUSES	10
1.7	SAFETY EQUIPMENTS IN THE MASTER BOOK	10
1.7.1	Emergency button	10
1.7.2	Green button To start cycle	11
1.7.3	Protection plate of the milling station	11
1.7.4	Main Switch	12
1.8	RESIDUAL RISKS	13
1.9	PURPOSES	14
1.9.1	Not provided uses, prohibited uses	14
2	TECHNICAL SHEET FOR MASTERBOOK 150	15
2.1.1	Electrical	16
2.1.2	Pneumatics	16
	Air quality provided to the Master Book	17
	DIN ISO 8573-1 – air quality class	17
3	STANDARD ACCESSORIES	18
4	TRANSPORTATION	19
5	STORAGE	20
6	LAYOUT	21
7	POSITIONING AND WORKSPACES	22
8	INSTALLATION	23
8.1	TECHNICAL STAFF FOR THE INSTALLATION	23
8.2	PHYSICAL CHARACTERISTICS OF THE AREA OF PLACEMENT	23
8.3	BOLSTER	23
8.4	WEATHER PROTECTION	23
8.5	LIGHT	23
8.6	ENVIRONMENTAL CONDITIONS	24
8.7	ELECTRICAL CONNECTION	25
8.7.1	Ground connection	25
9	TRAINING OF THE OPERATOR	26
10	POWER ON	27

10.1	FUNDAMENTALS	28
10.2	ELECTRICAL CONNECTION	30
10.3	PNEUMATIC CONNECTION	30
10.4	GROUPS DESCRIPTION	31
10.5	CHIPS ASPIRATOR	34
10.6	PUR TANK OPENING AND CLOSING. GLUE LOADING.	35
10.6.1	<i>Opening of the PUR tank</i>	35
	<i>WARNINGS ON THE OPENING OF PUR TANK</i>	35
10.6.2	<i>Preparation and loading of the pur glue</i>	37
10.6.3	<i>Cleaner loading</i>	39
11	FUNCTIONS OF MASTER BOOK	41
12	PREPARATION OF THE MACHINE TO PRODUCE A BOOK.	53
12.1	GLUE REFURBISHMENT PROCEDURE	53
13	COVER POSITIONING	55
	PREPARATION OF THE MACHINE TO MANUFACTURE A BOOK.	57
13.1	STARTING THE MACHINE	58
14	BOOK SPINE PREPERATION	61
14.1	PREPERATION OF LARGER BOOKS	62
14.2	CHANGING THE NOTCHING TOOL HEIGHT	63
15	CLEANING THE MACHINE	64
15.1	“END OF JOB” CLEANING	65
15.2	PROCEDURE TO CLEAN THE SPINE GLUE EXTRUDER.	66
15.3	PROCEDURE TO CLEAN THE GLUE SIDE EXTRUDERS.	69
15.4	DETAILS CLEANING	72
16	PROBLEMS - SOLUTIONS	75
16.1	CHIPS ASPIRATOR – LESS VACUUM:	75
16.2	CLAMP – IT DOESN’T START:	75
16.3	MILLING STATION – IRREGULAR CUT AND NOTCHING:	75
16.4	COVER PLATE MILLING STATION – IT DOESN’T OPEN / CLOSE CORRECTLY:	75
16.5	HEAD - OUT OF TOO MUCH OR LITTLE GLUE:	75
16.6	NIPPING STATION	75

1 INTRODUCTION



THE READING OF THIS OPERATOR AND MAINTENANCE MANUAL IS FUNDAMENTAL FOR THE SAFETY OF THE USER AND FOR THE PROPER USE OF THE EQUIPMENT.

We thank you to have bought our product. This machine has been designed specifically for your job and your applications with the help of a single worker, provides a high quality production and a wide range of functions.

This manual describes how to use the machine, starting from the configuration phase to the most important operations. This manual has been written in order to be easily understood also by user not trained about the use of this kind of machine. For the best use of the equipment, please read carefully this manual before to use the machine. After reading, we suggest you to save the manual in a safety place and don't hesitate to read him when necessary.

1.1 CE MARK

DICHIARAZIONE DI CONFORMITÀ CE
CE CONFORMITY DECLARATION
DIRETTIVA CE PER MACCHINE 2006/42/CE,
DIRECTIVE FOR MACHINES 2006/42/CE,
E SEGUENTI DIRETTIVE EUROPEE (ALLEGATO IIA)
AND FOLLOWING EUROPEAN DIRECTIVES (ANNEX IIA)

- **COSTRUTTORE, MANUFACTURER: K.G.S.SRL** Via Donizetti 5 – 20090 Assago (Mi) Italy
- RESPONSABILE DELLA COSTRUZIONE DEL FASCICOLO TECNICO / **RESPONSIBLE FOR PREPARING THE TECHNICAL DOSSIER: RACCANELLO ROBERTO**

CON LA PRESENTE DICHIARIAMO CHE LA FABBRICAZIONE DEL / **WE HEREWITH DECLARE THAT THE MANUFACTURE OF:**

- MODELLO TIPO / **MODEL TYPE : PERFECTBINDER MASTERBOOK 150**
- MATRICOLA / **SERIAL : MB150-XXXX**
- ANNO DI COSTRUZIONE / **MANUFACTURED IN 2013**

CORRISPONDE ALLE SEGUENTI DISPOSIZIONI NELLA VERSIONE ATTUALMENTE VALIDA / **IS IN ACCORDANCE WITH THE FOLLOWING DIRECTIVES AS IT IS :**

- Direttiva CE per Macchine 2006/42/CE / **Directive 2006/42/CE**
- Direttiva EMC 2004/108/CE / **EMC Directive 2004/108/CE**
- Direttiva sulla Bassa tensione 2006/95/CE / **Low Voltage Directive 2006/95/CE**

NORME ARMONIZZATE APPLICATE , IN PARTICOLARE
HARMONIZED STARDARDS, IN DETAIL :

- EN 1010
- EN 60 204-1
- EN 61 000-6-2, EN 61 000-6-3, EN 61 000-6-4

Assago , (MI) Italy
__/__/2013





Dott. Marco Alfredo Tumaini
Amministratore unico

1.2 SAFETY SIMBOLS

In the manual some symbols are used to inform about dangerous situations for people and/or things.

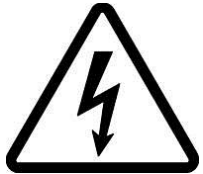

The following symbols mean dangerous situations for people and/or things.

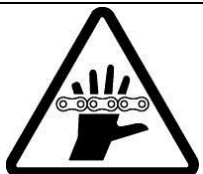
If you don't follow carefully the appropriate procedures, damages can occur to people and/or things, and in extreme situations also fatal accidents. Together with the symbols it is written also what to do.

	Attention – General danger!
	Attention – Electrical voltage! Risk of electric shock.
	Attention – Sharp blades! Risk of cut.
	Attention – Hot surfaces! Risk of burn.
	Attention – Risk of rolling parts! Risk of crushing.
	Attention – Risk of moving chain! Risk of crushing.

	In case of not warning of the symbols damages, also great, can happen to the machine and to the accessories.
---	--

1.3 SYMBOLS OF PROHIBITION AND OBLIGATORINESS

	This symbol means a prohibition.
	This symbol means an imperative.
	This symbol means that it is mandatory to read in this manual information regarding specific topics (for ex. related to the specifications of the electric and pneumatic connection).

MyBinding.com
5500 NE Moore Court
Hillsboro, OR 97124
Toll Free: 1-800-944-4573
Local: 503-640-5920

1.4 THE SAFETY DURING THE USE OF THE MACHINE

1.4.1 GENERAL



The manufacturer guarantees that the contents of this manual are in specification with the procedures required by the machine. The manufacturer therefore will be not responsible if the machine will be used in a different way.

1.4.2 SAFETY WARNINGS

Before the use of the machine, please read carefully the manual.
Save the manual for further needs.

By apply different procedures, and not the specific procedures described in the manual, can produce operational problems.

Please, read carefully the following safety rules.

	<p>It is forbidden to use the machine when occurs one of the following situations:</p> <ul style="list-style-type: none"> in explosive environment; in flammable atmosphere; in excessive dusty environments.
	<p>Danger!</p> <p>Failure to comply with some or all the instructions listed in this manual could cause damage to the machine and / or personal injury. The manufacturer is not responsible for an arbitrary and improper use of the machine such as:</p> <ul style="list-style-type: none"> Using the machine by untrained personnel; Use contrary to law; Incorrect installation; Defects in electrical power and / or pneumatic; Partial or total failure to comply with the instructions; Lack of maintenance and / or use of aftermarket parts; Changes or other actions not authorized by the manufacturer;

MyBinding.com
5500 NE Moore Court
Hillsboro, OR 97124
Toll Free: 1-800-944-4573
Local: 503-640-5920

1.5 SAFETY CLOTHING

Clothing to use during the cleaning and /or maintenance operations

	<p>Eye protection against any spray of PUR glue or high temperature cleaner</p> <p>Respiratory mask suitable for the glue you are using</p> <p>Protective gloves</p>
---	--

Tight clothing, to avoid that they remain engaged with protruding parts.

Long hair must be covered or otherwise collected by using e. g. a protective screen.

Do not wear watches or jewelry.

Safety clothing

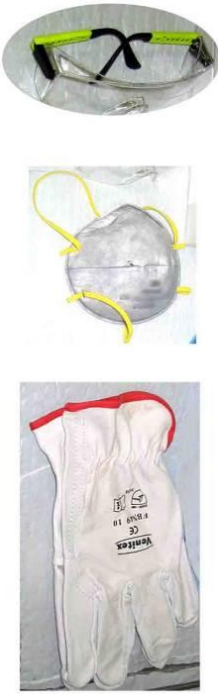
	<p>The safety clothing IS NOT INCLUDED in the machine and must be procured by the machine user.</p> <p>The operator should wear clothing appropriate to the situation and specially during the following operations:</p> <ul style="list-style-type: none"> -Maintenance -Replacing of the PUR glue -Cleaning of the PUR system <p>a) Eye protection against any spray of PUR glue or high temperature cleaner</p> <p>b) Respiratory mask suitable for the glue you are using.</p> <p>c) Protective gloves for high temperature</p>
--	--

MyBinding.com
 5500 NE Moore Court
 Hillsboro, OR 97124
 Toll Free: 1-800-944-4573
 Local: 503-640-5920

1.6 INSTALLATION OF ELECTRICAL CABLES AND HOUSES



Cables and houses must be put inside of special cable channels to avoid the people to stumble and get hurt.

1.7 SAFETY EQUIPMENTS IN THE MASTER BOOK

	<p>DANGER! It is forbidden to remove or render ineffective the safety guards for the safety of persons, and to tamper and / or modify, even partially, safety devices installed on the machine. In case of alarm signals due to the intervention of the safety, the operator must request the immediate intervention of technical people trained on the maintenance. The manufacturer is not responsible of any damage to persons or animals caused by tampering with the guards."</p>
---	---

1.7.1 EMERGENCY BUTTON

It is located on the front, easily accessible from the operator's position.

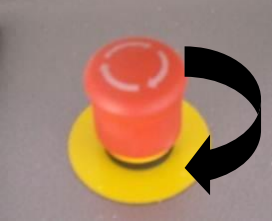
	<p>In the diagrams the emergency button is identified SB20.01</p> 
<p>ACTIVATION of emergency state: the push-button must be pressed</p>	<p>OFF state emergency stop: the button must be turned clockwise"</p>
	

1.7.2 GREEN BUTTON TO START CYCLE



The two front green buttons execute the command to start cycle, it means that the clamp closes and moves to the right, the mill will run the cut, the glue will be applied, and if the press has been activated will crush the book; all this happens if I put the book block in the clamp and place a cover on the press.

1.7.3 PROTECTION PLATE OF THE MILLING STATION

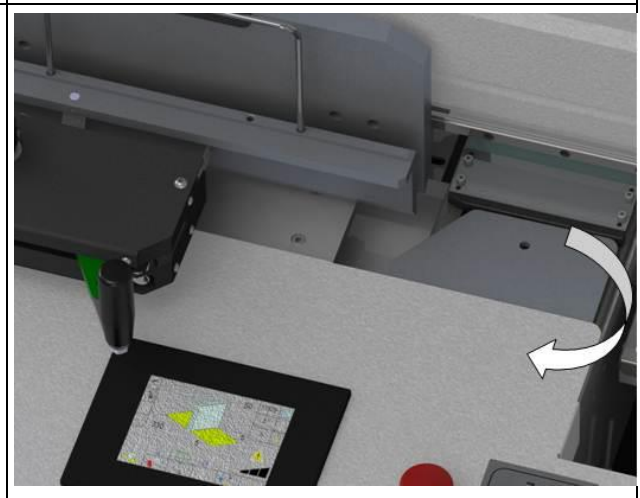
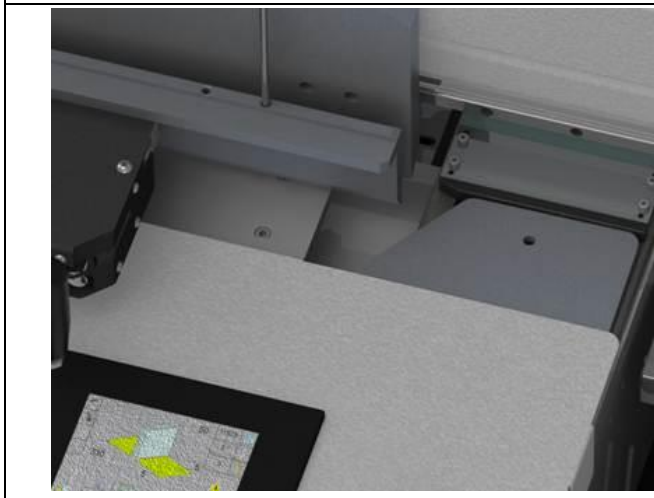

The plate consists of a mobile plate that, except when the book block is moving, covers the cutter in all operating conditions, even at a standstill

A spring exerts a constant force on the plate a force that covers the mill disc. The motor of the cutter is equipped with a brake.



1.7.4 MAIN SWITCH







It is located on the right side of the machine.

	<p>Position OFF The switch is open. The machine is off.</p>	
	<p>Position ON The switch is closed. The machine is on.</p>	

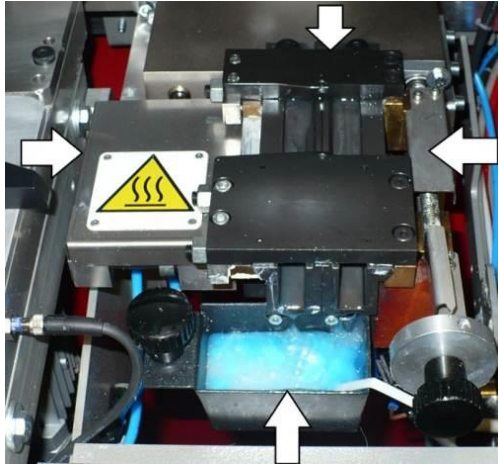
MyBinding.com
5500 NE Moore Court
Hillsboro, OR 97124
Toll Free: 1-800-944-4573
Local: 503-640-5920

1.8 RESIDUAL RISKS

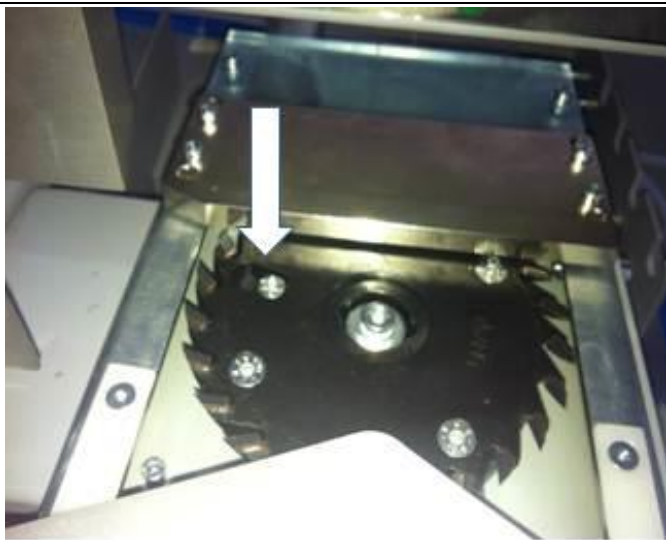
There are risks that cannot be completely eliminated by either protective or as designed by the machine.

		<p>Area of the glue head.</p> <p>Attention – Hot surfaces! Risk of burn. Use protective gloves.</p>
		<p>Area of glue loading.</p> <p>Attention – Hot surfaces! Risk of burn. Use protective gloves.</p>
		<p>Area of the mill.</p> <p>The disc contains several types of milling cutters. Use protective gloves, in case of removing the Notching Roughening or the brush.</p>

MyBinding.com
 5500 NE Moore Court
 Hillsboro, OR 97124
 Toll Free: 1-800-944-4573
 Local: 503-640-5920



1.9 PURPOSES

The machine is used to bind books using the following materials:

- a) Signatures, or sheet of paper (printed or not) for the block book
- b) Cardboard as cover of the book

within the limits specified in the data sheet, included in this manual.

1.9.1 NOT PROVIDED USES, PROHIBITED USES

	<p>Any other use such as,</p> <ul style="list-style-type: none"> - Milling / Roughening of book spines already bounded (adhesive binder, stitching book, sewing book, etc.) - Use of materials other than those specified in a) and b) - Operations beyond the technical specifications are not to be regarded as intended use. 	
--	--	--

The user has the total responsibility of the damages to people or things due to an improper use, outside of their intended use.

MyBinding.com
 5500 NE Moore Court
 Hillsboro, OR 97124
 Toll Free: 1-800-944-4573
 Local: 503-640-5920

2 TECHNICAL SHEET for MasterBook 150

Machine features:

Cycle/Hour	150 cycles
Spine length	from 120 to 380mm
Workable height of the book	from 110 to 320mm
Max. Cover size	700x360/222x120 mm
Workable thickness of the book	from 2 to 50mm
Max. Cover Weight	from 120 to 400 g/m ²

Control Screen

Touch - Screen	Yes
Copy Counter	Yes
Diagnostic and Check	Yes
Setting size, temperature control	Yes
Speed	Yes

Book Loading

Adjustment of the clamp	Manual
Clamp opening/closing	Manual

Spine preparation

Milling disks	Ø 110 mm (optional)
---------------	---------------------

Roughening for spine processing 2

Chips aspirator	Included in the machine
-----------------	-------------------------

Glue application system

Tank PUR/Hot-Melt glue	3 Kg sealed
Extrusion system of PUR/Hot-melt	integrated and sealed
Extrusion head adjustment	Manual
Glue stops	Adjustable by Touch-Screen
Cleaning / sealing	Yes

Press:

Press	Electric (servo-controlled)
Adjustment	Pressing time

Mechanical Adjustment

Cover back bar adjustment	Manual
Cover loading	Hand made by the operator

Dimensions / Weight

Length	1400 mm
Width	880 mm
Height	1270 mm
Weight	210 Kg

Power consumption

Electrical power Max.	4Kw
Power grid	220 V ±5%, 50/60 Hz

2.1.1 ELECTRICAL

Electrical power 220 V \pm 5%, 50/60 Hz

Power of the machine	Protection fuses on the power network are duties of the customer
Distribution cabinet, customer side	16 A Differential protection class A 300mA

2.1.2 PNEUMATICS

Supply pressure

The pneumatic system of the user must ensure, in the inlet connection of the compressed air in the perfect binder, the following values:

Min.: 7 bar

air consumption: 160 NI/min

air quality: **Class 3**

Pneumatic characteristics for the machine

Compressed air consumption

100 NI/min

Calibration of input gauge

6 bar

Min. working pressure

5.5 bar. If the pressure value falls below this value the machine enter in an “alarm” condition

Diameter of air inlet



6 mm

The 6 mm diameter house for the connection to the compressor is not provided together with the machine.

It is suggested the use of a compressor equipped with the automatic condensate drain, to avoid verifying weekly if there is some water inside the compressor.

It is suggested to use a silenced compressor, if the compressor is located inside the working plant.

MyBinding.com
 5500 NE Moore Court
 Hillsboro, OR 97124
 Toll Free: 1-800-944-4573
 Local: 503-640-5920

	<p>Air quality provided to the Master Book CLASS 3, DIN ISO 8573-1 Dust: 5 micron - 5 mg/m³ Water: -20°C - 0,88 g/m³ Oil: 1 mg/m³</p>
	<p>The compressed air system upstream of the machine must be equipped with a dryer. Periodically check the quality of the compressed air supplied to the machine and the operating values .</p>

AIR QUALITY PROVIDED TO THE MASTER BOOK

To make work the pneumatic devices in an affordable, efficient and safe way, the compressed air supplied to the pneumatic device must have the following quality features:
 Pressure, Quantity, Water content, Solids content, Oil content.

DIN ISO 8573-1 – AIR QUALITY CLASS

The manufacturers of pneumatic components refer to the quality of compressed air to be used on their products, referring to the table below

Classe	Corpi solidi		Contenuto d'acqua	Contenuto d'olio
	Max. dimensioni delle particelle [µm]	Max. densità delle particelle [mg/m ³]	Max. punto di rugiada [°C]	Max. concentrazione olio [mg/m ³]
1	0,1	0,1	-70	0,01
2	1	1	-40	0,1
3	5	5	-20	1
4	15	8	3	5
5	40	10	7	25
6	-	-	10	-
7	-	-	non specificato	-

The compressed air used in the industry contains water, oil, dust and other impurities. The interaction of these elements produces an aggressive mixture that can damage the compressed air devices and also the PUR glue contained in the PUR tank, the results will be a low quality production and increased maintenance costs.

3 STANDARD ACCESSORIES

The standard composition includes:

- **Cleaning Kit**
- **Start- up Kit**

CLEANING KIT

<p>Polizene green spatula (to remove excess glue or cleaner)</p> <p>Steel Wire Ø0.4 (for cleaning the channels of leakage of the lateral glue)</p> <p>Lamella thickness of 0.4 (for cleaning the slit of leakage of the spine glue)</p> <p>Spare Headless screws for the closure of the ducts</p> <p>Protective gloves</p> <p>Set of allen keys</p> <p>Small arches for supporting the book block in the clamp</p>	
--	---



START-UP KIT

<p>One pack of 2 kg of PUR Glue Henkel</p> <p>One pack of 2 litres of beans Cleaner-Blue Henkel</p>	
---	--

MyBinding.com
 5500 NE Moore Court
 Hillsboro, OR 97124
 Toll Free: 1-800-944-4573
 Local: 503-640-5920

4 TRANSPORTATION

	<p>The Master Book must be handled by a heaver. It can be got ONLY along the 2 long sides, front and rear side.</p> <p>For the final positioning or small movements can be used a trans-pallet.</p> <p>The machine can be raised by trans-pallet only in the 2 long sides, front and rear.</p>
---	---

	<p>DANGER! For no reason the staff is authorized to pass under a suspended load during transport or in the proximity of. The producer is not responsible for what happens during this operation, to be carried out by qualified and authorized personnel, with the necessary individual safety protections (suit, shoes, gloves, helmet and glasses).</p>
	<p>Attention! <i>The machine is balanced.</i> In any case keep the forks low. In case of unbalance use weights. It is forbidden to hold by the hands the projecting parts. The machine and its parts must be protected from the weather outside. In particular, water, dust and moisture can oxidize certain elements of the machine, damaging them irreversibly. Follow the usual precautions to avoid falls and bumps.</p>

IMPORTANT

- a) We do not provide tools for docking and lifting.
- b) The disposal of packaging materials will be provided by the recipient and must be conducted in accordance with the local regulations.
- c) Remove dust and dirt accumulated during the transportation.

MyBinding.com
 5500 NE Moore Court
 Hillsboro, OR 97124
 Toll Free: 1-800-944-4573
 Local: 503-640-5920

5 STORAGE

The information contained in this section must be observed in case of temporary storage of the machine that may occur in the following situations:

- installation of the machine not immediately after its delivery.
- uninstalling the machine.
- storage awaiting a new location.

The machine must be stored and transported under conditions of SAFETY as shown in the table below.

<i>Conditions of transportation and storage</i>	
Temperature average	-5/+55°C
Humidity average	30/90%
Lighting	Adequate natural and / or artificial
Weather	Adequate weather protection
Space required	Adequate to allow the operations of lifting and carrying in SAFETY.
Horizontal bolster	Horizontal bolster must have a capacity in excess of the total mass of the machine.
In the case of removal or unused for long periods (over 30 days), it is necessary to drain the glue system and to put inside the protection cleaner.	The damage caused by this failure will void the warranty of the glue device.
During periods of downtime you should not open the tank containing the glue, otherwise it accelerates the deterioration creating serious permanent damage to the glue device.	The damage caused by this failure will void the warranty of the glue device.
Protect with anti-corrosive products the parts subject to wear and work plans. Ref. to the section "maintenance".	
Do not climb or place any objects on top of the machine	

6 LAYOUT

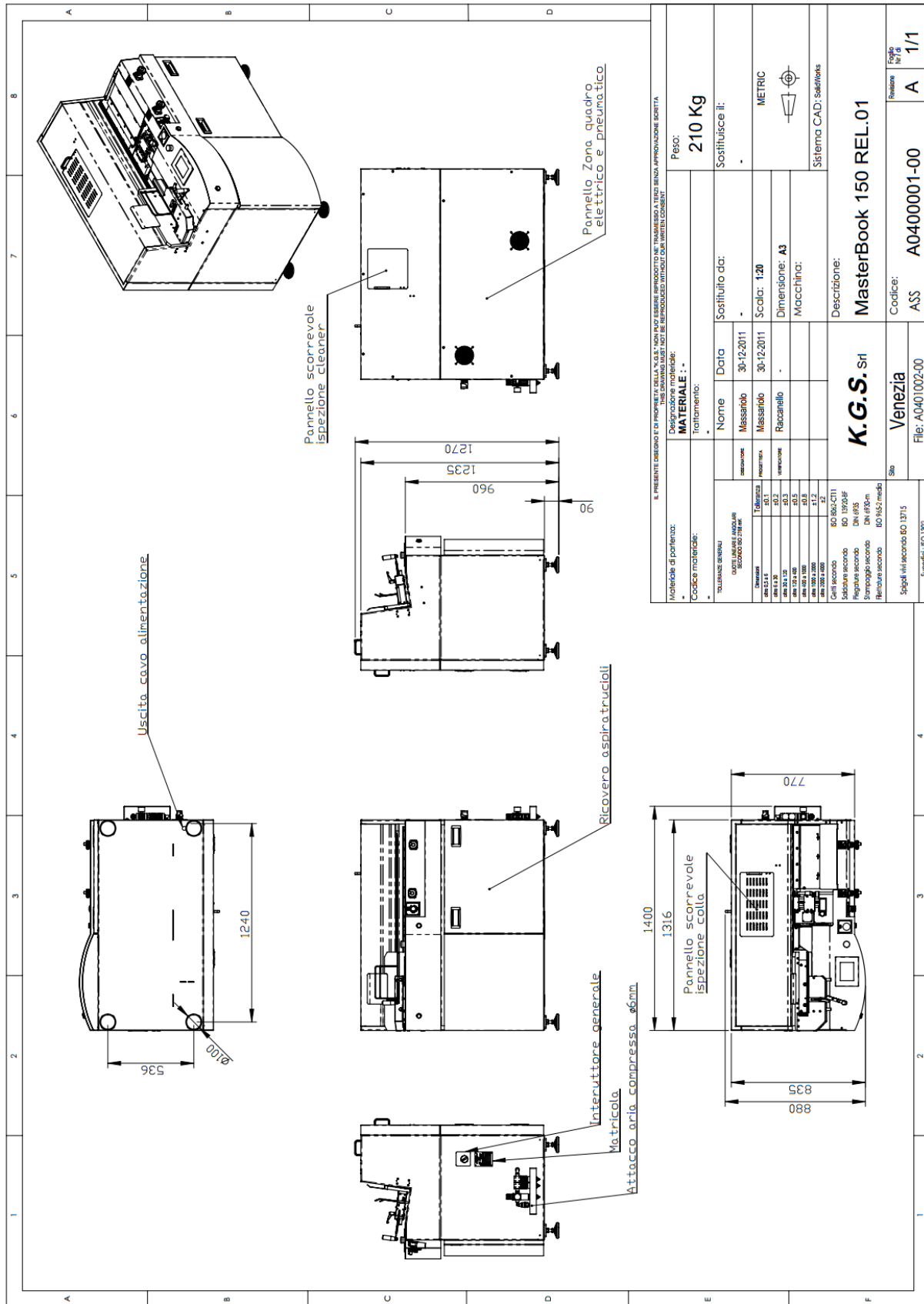

7 POSITIONING AND WORKSPACES

Positioning

The Master Book must be positioned so as to have a clear space around of at least 80 cm, and around the work area at least 150 cm. The room where the machine is installed must be properly ventilated with air change according to law

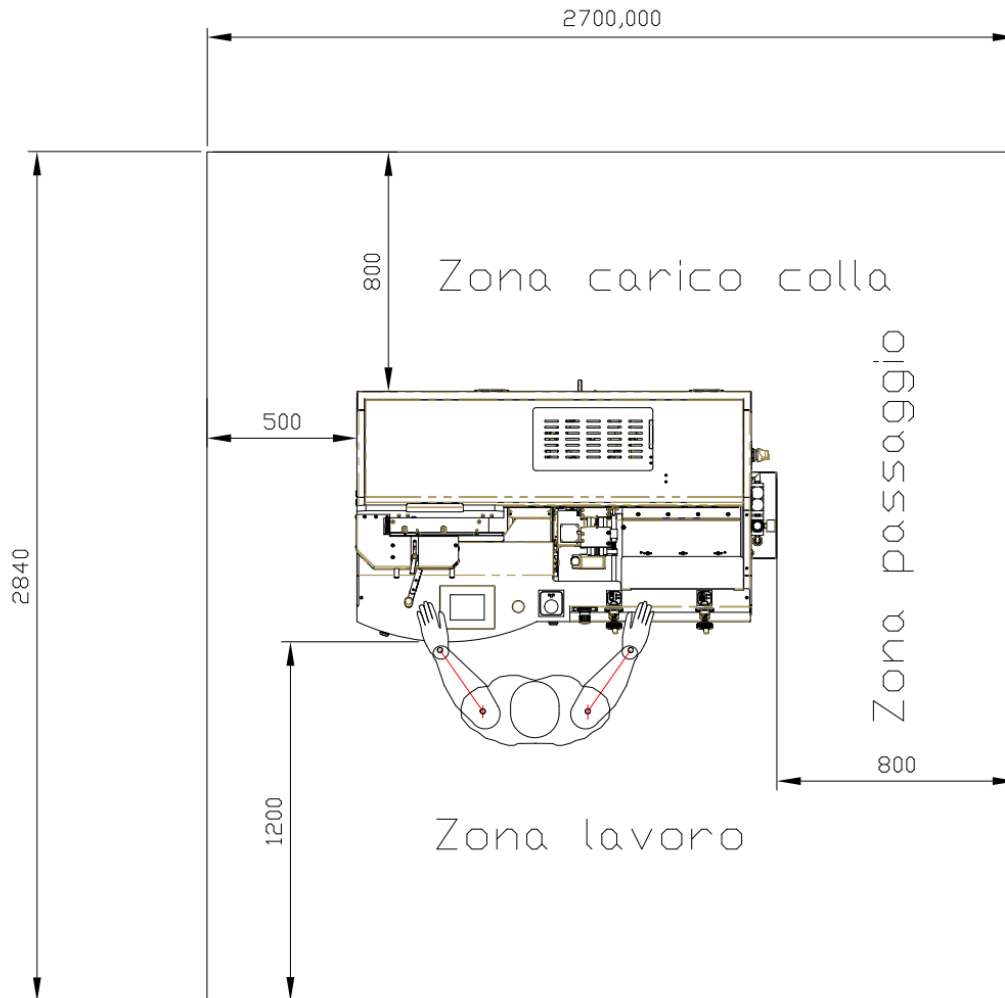

Workspaces

<i>Glue loading area</i>	Glue loading area, the operator enter in this area to load the glue in the machine. Access area for the maintenance, for access to the electrical and pneumatic panel.
<i>Transit area</i>	Used to transit from the work area to the glue loading area.
<i>Operator's work area</i>	Operator's work area during the normal use of the machine.
<i>Right side of the machine</i>	It is not necessary to leave an available space

8 INSTALLATION

8.1 TECHNICAL STAFF FOR THE INSTALLATION

The machine must be installed by people specifically trained and authorized by K.G.S. .

8.2 PHYSICAL CHARACTERISTICS OF THE AREA OF PLACEMENT

In addition to the overall dimensions of the machine given in the previous chapter, you must also meet the following conditions:

Near the area of placement of the machine should be arranged the sources of electric power and pneumatic following what is written in this manual.

Provide sufficient space for normal use, maintenance of machinery, for any command and for additional equipments to connect. Refer to the draft in the chapter of the positioning.

The chosen site should not be close to deposits of flammable materials, or to operational sites that may create flammable or explosive atmospheres.

For the installation you must choose an operational area depending on the size of the machine parts and lifting equipment selected and pay attention to the presence of any obstacles on the road (equipments, walls, etc.).

8.3 BOLSTER

The machine requires no special foundations. It must be ensured the availability of an industrial floor.

The producer has no responsibility about construction of foundations (resistance calculation, thick reinforced concrete, etc.), which are under responsibility of the customer or company performing the design and construction of the foundations themselves.

The Master Book rests on four feet of 100 mm diameter.

8.4 WEATHER PROTECTION

The machine must be placed indoor, protected from direct contact with atmospheric agents.

8.5 LIGHT

To use and maintain in a safety way the machine a good light is needed. The room lighting should have a value that should allow normal operations without causing risks to the shadows.

8.6 ENVIRONMENTAL CONDITIONS

The values of temperature and humidity should be within the values in the table below.

In case of use of the system in corrosive environments it is important to intervene in the maintenance of the machine with adequate time to avoid excessive wear of components.

	MIN	MAX
Room temperature	5°C	40°C
Relative humidity	20%	80%

8.7 ELECTRICAL CONNECTION

Electrical cable

The end of the cable is prepared according to the destination of the Master Book.

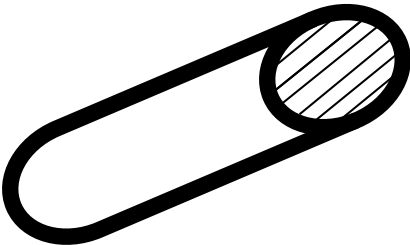
	<p>a) With the European standard plug with protective earth (PE) mounted on a 3 meters length cable</p>
	<p>b) Cable length of 3 meters with sectioned end, with the earth conductor (PE) It is the responsibility of the user to adjust the connection cable in accordance with the applicable legislation.</p>

8.7.1 GROUND CONNECTION

The Perfect Binder is equipped with an earth conductor (PE).

	<p>During the installation the customer must realize the ground connection in accordance with the applicable legislation.</p>
---	---

MyBinding.com
 5500 NE Moore Court
 Hillsboro, OR 97124
 Toll Free: 1-800-944-4573
 Local: 503-640-5920

9 TRAINING OF THE OPERATOR



DANGER! The operator must be trained about the operations to perform during the occurrence of possible faults, malfunctions or conditions of danger to themselves or others, and anyway he must perform the following procedures:

Stop the machine quickly by pressing the emergency button (red button installed aboard of the machine herself);

Do not carry out operations that go beyond the specific knowledge and techniques;

Immediately inform their superior head, avoiding taking personal initiatives.

It is assumed that the operating and maintenance personnel possess the following minimum requirements:

- Culture in general and specific enough, each to his ability, to read and understand the contents of the manual including the correct interpretation of drawings and diagrams, pneumatic and hydraulic;
- Ability to understand correctly the symbols and video messages;
- Overall knowledge of the machine and of the plant in which it is installed;
- Specific experience in the applied technology;
- Knowledge on what to do in an emergency,
- The availability of personal protection equipment and how to use them.

10 POWER ON

- 1) Be sure that the machine is pneumatically fed in the proper way
- 2) Turn on the machine turning the main switch
- 3) Open the valve you have on the premelter
- 4) Close the inspection panel on the top side

On display you will have:

- Put the cover
- Machine with cleaner
- Machine not in temperature
- Close the clamp

- 5) Press on display the icon bottom left to make the machine preset,

Press together the two buttons placed on the front part of the machine and hold them until the end of the operation.

On display:

- Machine with cleaner
- Low temperature

- 6) When the temperature icon becomes green, press the button glue cleaner to load glue

- 7) Set the values, the length of the book and the glue stop (select the correct speed base of book thickness)

- 8) Open the clamp at the thickness of the book you want to produce.

- 9) Open the head at the thickness of the book you want to produce.

- 10) Position the cover on the rear ledge of the press at the desired dimension.







- 11) Put the book in the clamp







- a. put the cover
- b. close the clamp
- c. press together the two buttons placed on the front part of the machine and hold them until the book arrives on the press
- d. open the clamp
- e. press together the two buttons placed on the front part of the machine and hold them until the clamp return in the initial position

When the book is finished, remove it carefully.

Repeat all the operations of the point 11) to produce another book with the same dimensions of the last one otherwise repeat the operations from point 7).

10.1 FUNDAMENTALS

	<p>Pay Attention during the glue loading because of the high temperature, as indicated by the label, and use protective systems such as gloves.</p>	
	<p>When you operate with PUR glue or with glue that is harmful to health, you have to adopt all the safety systems to handle these kind of substances, especially when you open the glue tank or when you replace the glue or you do the cleaning procedure for the nozzle and the premelter.</p>	
	<p>The tank has to be added with the same type and brand of glue. You can use a different kind of glue only when the system is completely empty and cleaned by using the Blue-Cleaner.</p>	<p>Drain as much as possible the glue that you want to replace. Enter in the tank a quantity of about 600g of Blue-Cleaner and make it protrude from the main slot and the channel of the glue; if at the end of this cleaning cycle you are not sure that from the valve 100% Blue-Cleaner exits, repeat the operation.</p>
	<p>Never open the tank when it is cold.</p>	<p>Possibility to break the seal gasket. In addition to that the air humidity will enter into the tank and will be trapped causing premature ageing of the glue (curing) with likely obstructions and need of maintenance.</p>
	<p>The machine cannot stay with the glue tank opened more than 10 minutes if there is PUR glue inside.</p>	<p>The glue in contact with moist air modifies her composition, creating damages to the machine.</p>
	<p>The machine can't stay with the glue system empty for more than 10 minutes</p>	<p>The PUR glue dries permanently; in this case you risk permanent damage to the glue system. If you don't have a glue cartridge available, put in the tank at least 500 grams of Blue and wait to be melted before to switch off the machine.</p>

	<p>The machine cannot be without air compressed when the glue station is still hot.</p>	<p>Without air compressed inside the machine, the valve that handles the glue spilling in the head could open damaging itself.</p>
	<p>Clean the nozzle of the glue station and of the tank as described in the following chapters.</p>	<p><u>Any failure to comply with these procedures will make void the guarantee of the machine.</u></p>
	<p>On premelter and on glue nozzle use the temperatures suggested by glue producer.</p>	
	<p>Avoid opening the lid frequently, the moisture in the air damages the features and durability of the glue.</p>	
	<p>The depletion of the glue is found in two ways: the lack of glue on the book; issuing at the extrusion zone glue clear glue mixed with air vents and glue bubbles.</p>	
	<p>When you finish the glue and insert a new cartridge you have to wait about 20 min before the new glue melts.</p>	
	<p>The machine is not operational until the set temperature is reached and the time set by the manufacturer is elapsed.</p>	



MyBinding.com
 5500 NE Moore Court
 Hillsboro, OR 97124
 Toll Free: 1-800-944-4573
 Local: 503-640-5920

10.2 ELECTRICAL CONNECTION

	<p>Make sure that the cable of the Master Book is connected to electricity network with the specified features.</p> <p>Turn on the main switch located on the right side of the machine, turn right to achieve the position 1 = (ON).</p>
---	---

10.3 PNEUMATIC CONNECTION

Connect the pneumatic power source following the procedure:

	<p>Connect the house (6mm diameter) to the quick of the Master Book</p>
	<p>To disconnect the hose of the machine, it is necessary to rotate the blue part of the sleeve. With this procedure you will flush the air from the machine. When you have finished it will be possible to pull out the sleeve pushing upwards the blue part and pulling out the sleeve downwards. The sleeve has a seal system that once pulled out does not allow air passage</p>

	<p>Danger! Risk of collision due to uncontrolled movements of the houses subjected to passage of compressed air.</p>
---	---

10.4 GROUPS DESCRIPTION

	<p>Position OFF</p> <p>Main switch open. The machine is off.</p>	
	<p>Position ON</p> <p>Main switch closed. The machine is on.</p>	
	<p>1) CLAMP 2) MILLING STATION 3) GLUE STATION 4) PRESS</p>	
	<p>1) CLAMP</p> <p>A. Tag for book thickness B. Knob to adjust the slot C. Lever for opening/closing D. Sensor for presence of book E. Front support for the book F. Rear support for the book</p>	

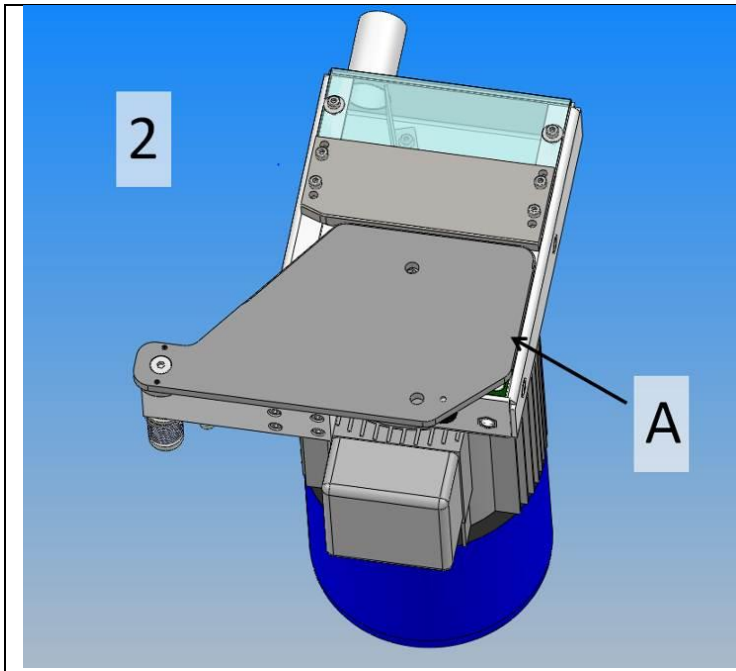

2) MILLING STATION

- A. Milling disc protection

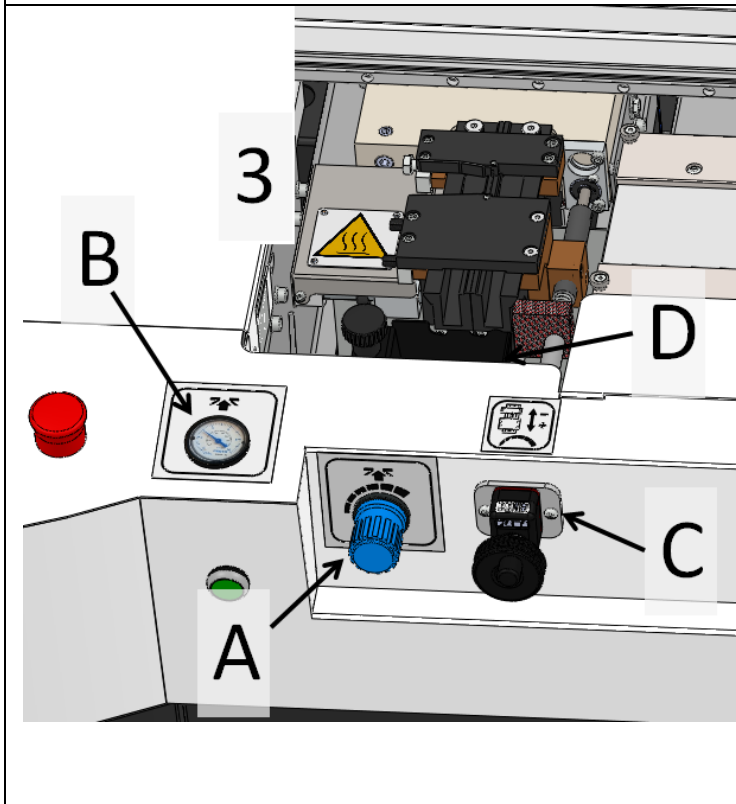

3) GLUE STATION

- A. Adjustment for glue pressure
It allows adjusting the glue quantity spilling out from the extruder.
- B. Manometer for glue pressure
Indicative values
Pressure = 0 NO GLUE (do not use the machine)
Pressure = from 1.2 to 1.8 bar for books until 5 mm thickness
Pressure = from 1.8 to 2 bar for books from 5 to 10 mm thickness
Pressure = from 2 to 3 bar for books from 10 to 30 mm thickness
Pressure = more than 3 bar for books from 30 to 50 mm thickness
- C. Adjustment for head slot
Values of slot min. 1mm Max 50mm
- D. Bowl for glue collection

MyBinding.com
 5500 NE Moore Court
 Hillsboro, OR 97124
 Toll Free: 1-800-944-4573
 Local: 503-640-5920

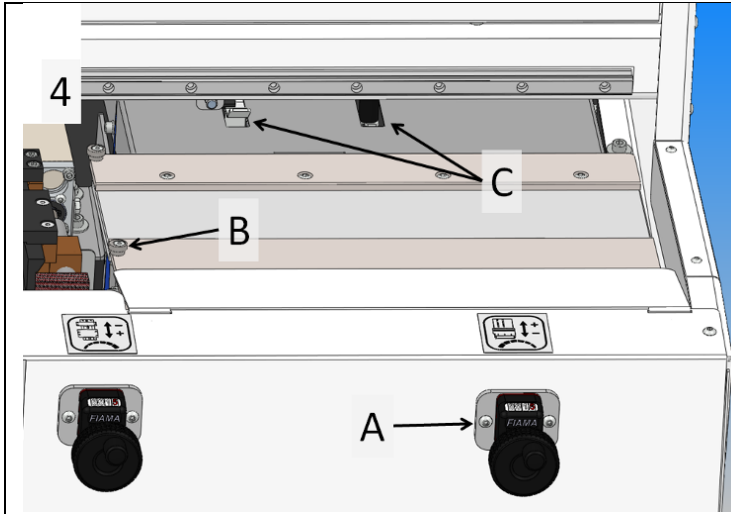

4) PRESSA

- A. Adjustment of beat for the cover
- B. Adjustment for square cover
- C. Beat for the cover

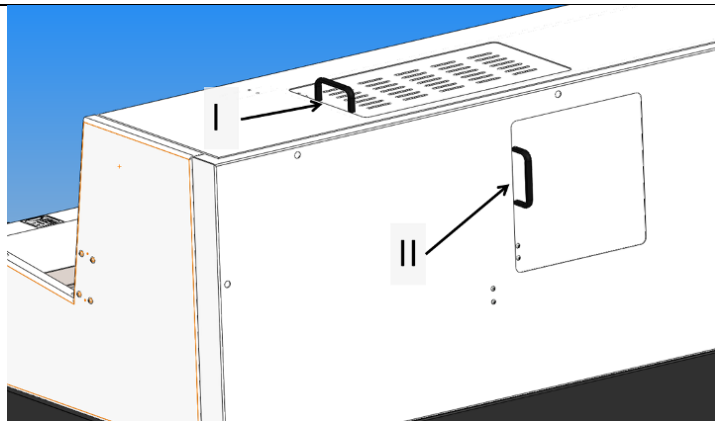

On the back and over the machine

- I. Access to glue tank
- II. Access to cleaner tank

The machine does movements only when the panels are closed.

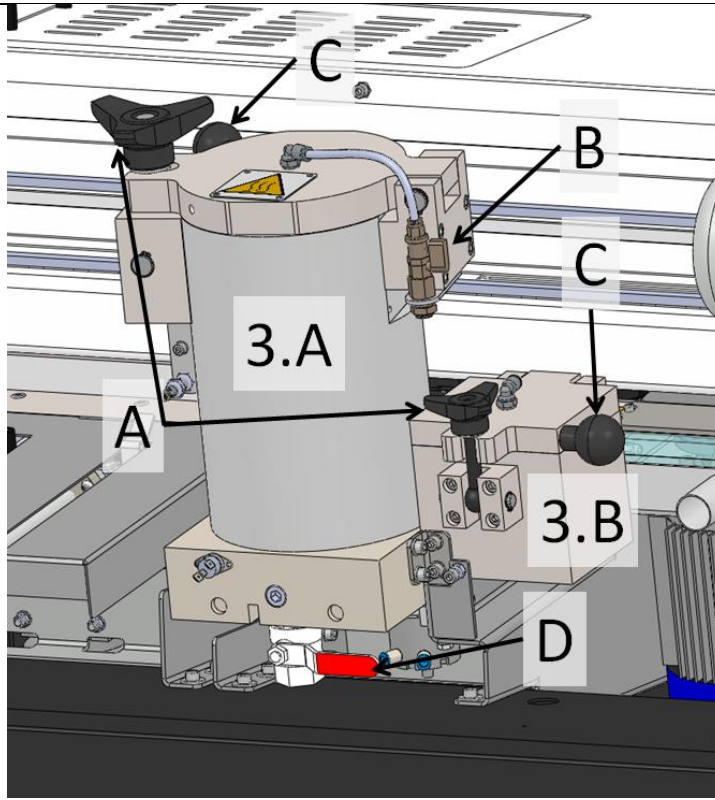

3.A) GLUE TANK

3.B) CLEANER TANK

- A. Handwheel to open the tank
- B. Valve ON OFF for air in tank
- C. Handgrip to open
- D. Valve to drain glue

10.5 CHIPS ASPIRATOR

The chips aspirator is located inside the cabinet of the Master Book and is electrically connected to the Master Book itself.

When the Perfect Binder is delivered, the chips aspirator is ready, mechanically (aspiration tube) and electrically connected, he switches on and off together with the Milling Station.

Front picture: chips aspirator (see arrow)

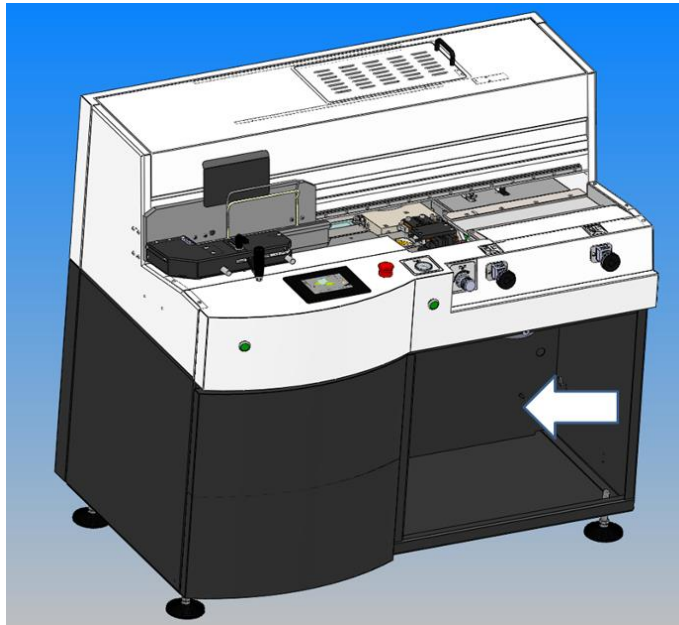

Aspiration tube

In the back of the Perfect Binder, connected to the back preparation station.

Switch

It must be in “on” position (I = ON) during the operation of the Perfect Binder.



Every day the chips aspirator must be emptied and cleaned to be always efficient.

10.6 PUR TANK OPENING AND CLOSING. GLUE LOADING.





10.6.1 OPENING OF THE PUR TANK

To access the glue tank it is necessary to open the sliding door provided with handle.





The opening of this protection put the machine in a state of emergency and reduces the pressure of the glue tank while the Cleaner tank remains at a pressure approximately of 2 Bar.

The machine can't work with the back door open

WARNINGS ON THE OPENING OF PUR TANK

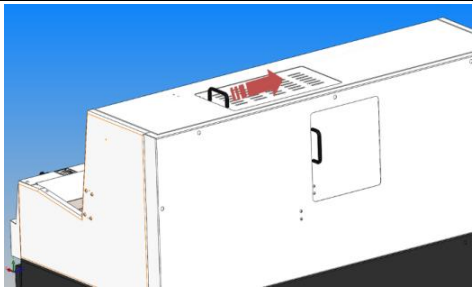
	<p>Wear hand protection, all parts are at high temperatures.</p>
	<p>Wear protections for face, respiratory mask suitable for the glue you are using and protection glasses.</p>
	<p>Never open the tank when it is COLD. Possibility of breaking the seal gaskets and because of this The air moisture would enter and remain trapped in the tank causing premature aging (curing) of the PUR glue with probable clogging and maintenance need.</p>
	<p>Avoid to open the PUR tank with no reason.</p>
	<p>Limit the opening time. Close the tank as soon as possible</p>

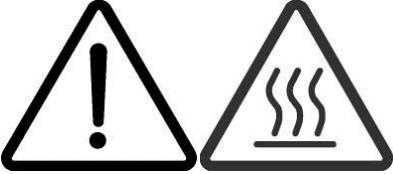
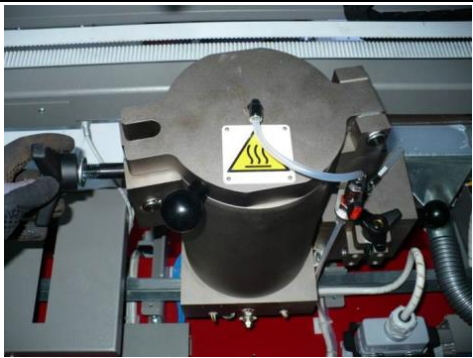



Please follow scrupulously the sequence below.

	<p>Open the sliding door in the back of the machine, provided with a handle. The machine goes into a state of emergency and takes away the pressure to the glue tank, while the cleaner tank remains under pressure of 2 bar about.</p>
	<p>Loosen the lock knob. Turn it counter clockwise. Attention! High temperature! Wear protective gloves.</p> 
	<p>Tilt locking knob to its rest position. The cover is so free to open.</p>
	<p>Lift the cap to the maximum opening grabbing the lateral knob</p> 

10.6.2 PREPARATION AND LOADING OF THE PUR GLUE



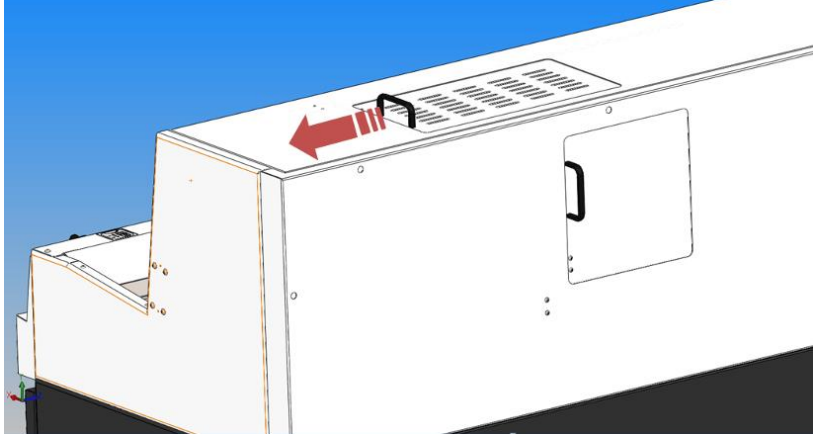

		<p>Take a package of glue, verify the integrity of the aluminium colour pack, and check the expiration date printed in the package</p>  <p>Please read the SAFETY cards of the used glue, and follow all the instructions of the manufacturer.</p>
		<p>Cut the foil, by using a sharp tool.</p> 
		<p>Remove completely the foil.</p>
		<p>Insert the cartridge into the tank. Attention! High temperature! Use protective gloves.</p> 

MyBinding.com
5500 NE Moore Court
Hillsboro, OR 97124
Toll Free: 1-800-944-4573
Local: 503-640-5920

		<p>Close the cap</p>
		<p>Remove the knob, paying attention to high temperature components. Turn the knob clockwise vigorously to tighten the tank.</p>
		<p>Close the sliding panel in the back of the machine, provided with a handle.</p>

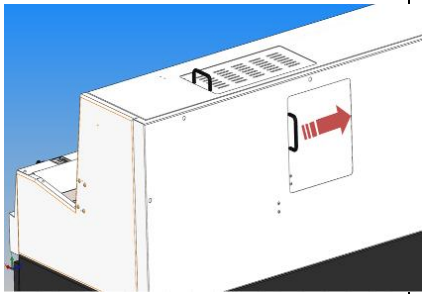
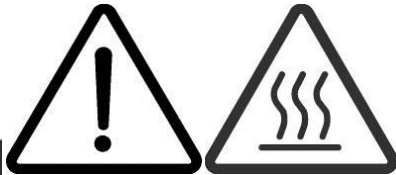
MyBinding.com
 5500 NE Moore Court
 Hillsboro, OR 97124
 Toll Free: 1-800-944-4573
 Local: 503-640-5920

10.6.3 CLEANER LOADING

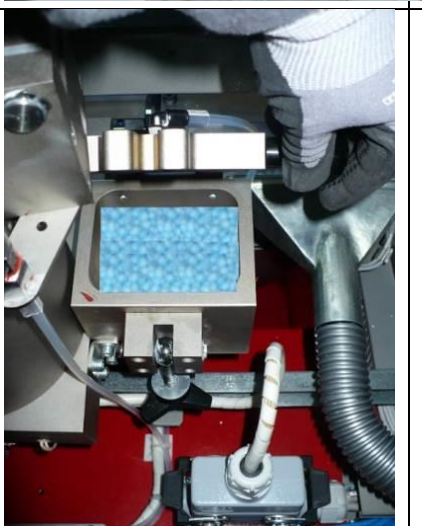
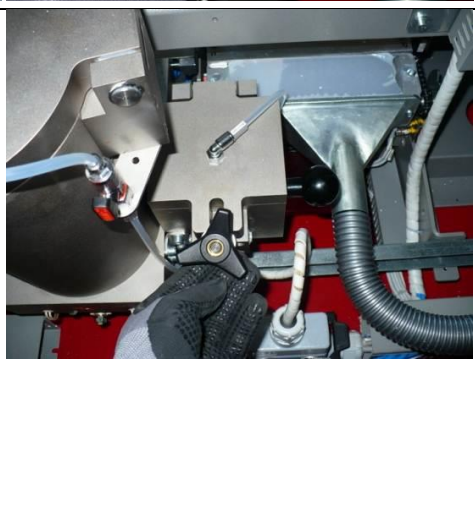
	<p>Open the sliding door in the back of the machine, provided with an handler.</p> <p>Attention! High temperature! Use protective gloves.</p>  <p>Read carefully the SAFETY cards of the used cleaner, and follow all the instructions of the manufacturer.</p>	
		<p>By loosening the knob of the cleaner tank you will notice an air leak, this is normal as the machine continues to provide air to the tank.</p>
		<p>Fill the tank with cleaner to about 3 / 4 of its volume by using a small container.</p>
		<p>Close the cap using the knob on the side and pay attention to the high temperature components.</p> <p>Lift the locking knob.</p>



Tighten the knob until the noise of escaping air disappears.

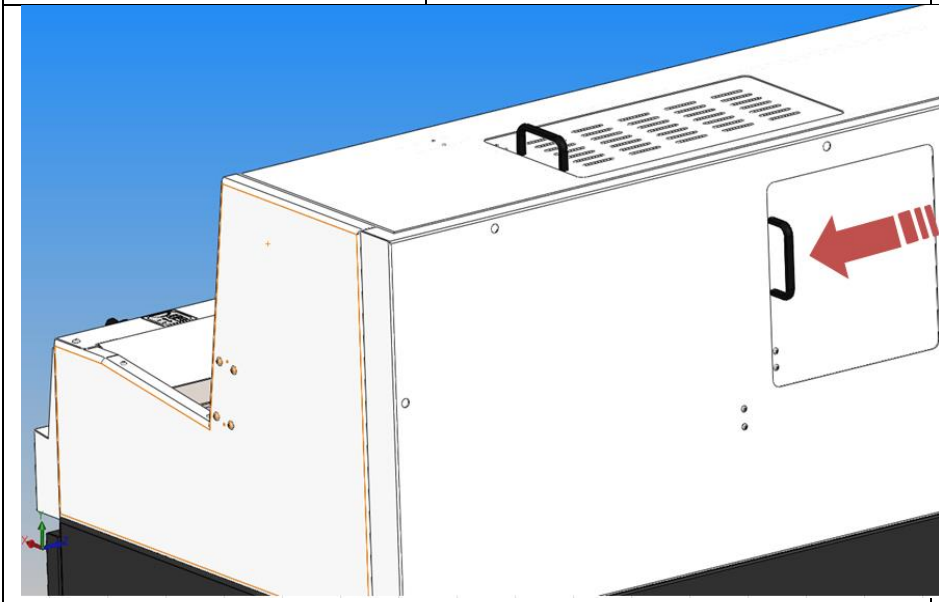

Close the sliding door in the back of the machine, provided with a handle.

MyBinding.com
5500 NE Moore Court
Hillsboro, OR 97124
Toll Free: 1-800-944-4573
Local: 503-640-5920

11 FUNCTIONS OF MASTER BOOK

MB150 Start-up page for the operator

Preliminary Operations:

Turn on the machine using the main switch.



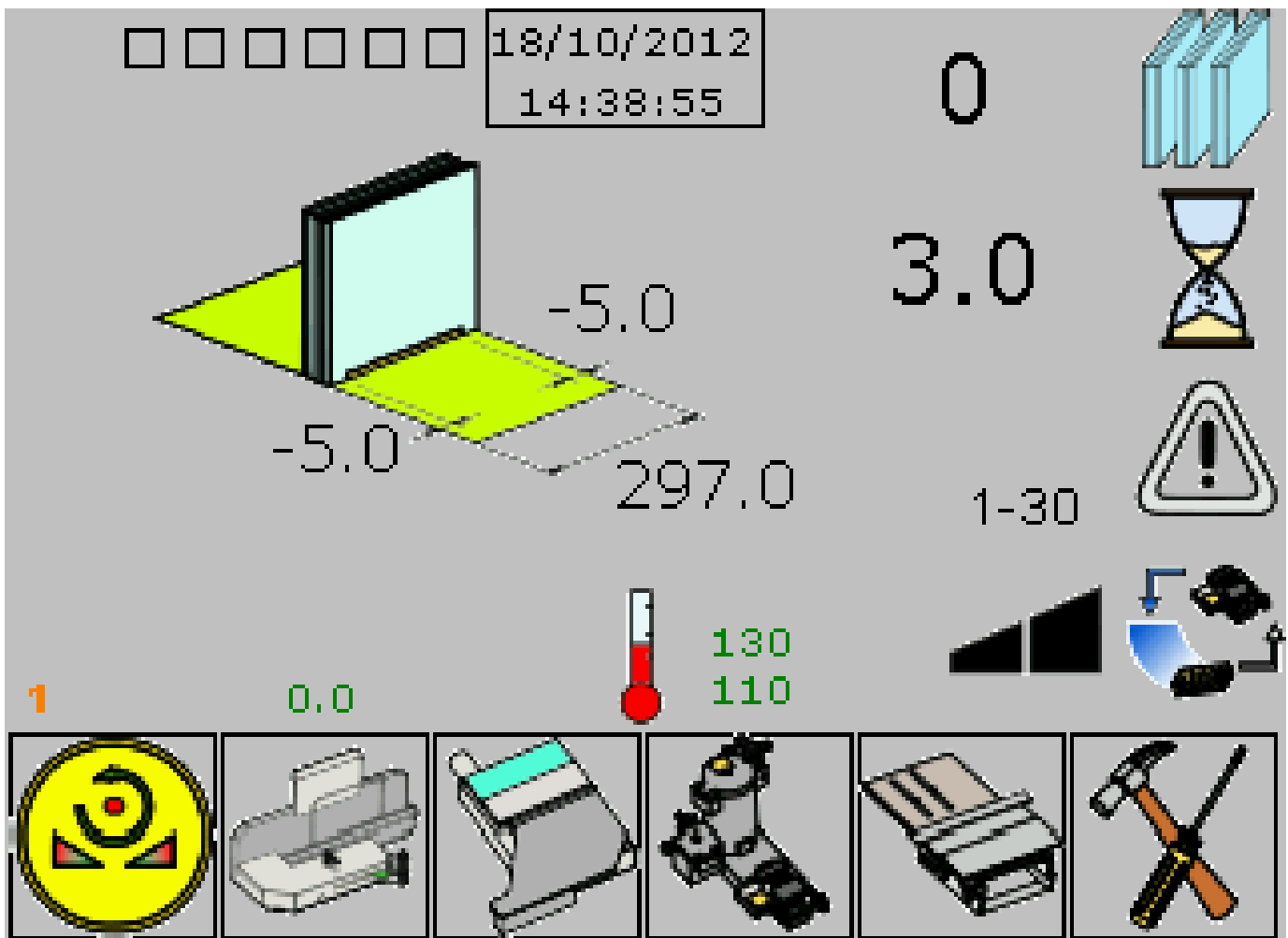





While you are doing this, on display you will see the set up page from which it will be possible to access to the main features of the Master Book, see image below.

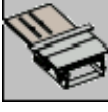

Basic principles:

1. It is necessary to stay in the start-up page to be able to produce books (see previous image)
2. Put the book into the clamp
3. Close the clamp using the specific handle. If the clamp is not closed a dedicated sensor does not allow the machine to start the cycle and leave the machine in alarm.
4. Press together the buttons on the front side of the machine and hold them until the carriage is not on the press. If you release one or both buttons, the machine stops and goes into alarm status. In this condition it is compulsory to remove the book from the clamp and do the pre-set of the machine.
5. The press automatically comes up.
6. Open the clamp as indicated by the display. If the clamp does not open, the machine does not allow the carriage to go back. Due to the sensitiveness of the sensor, it can happen that with big thickness books (50 mm) the sensor keeps reading that the clamp is not opening. In this case after open it, press the button OK in order to allow the carriage to return in position.
7. Press the right button and hold it to make the carriage to go back. If you release the button while the carriage is going back in loading position, the machine stops and goes into alarm status. In this case it is necessary to remove the book from the clamp and do the preset of the machine.

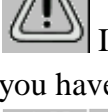
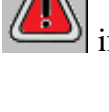
Icons, texts and meanings:

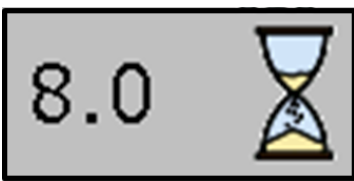
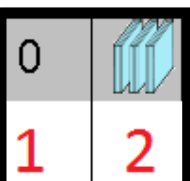
1.  Icon (button) indicating that it is necessary to do a preset of the machine.
2.  Icon (button) to access carriage parameters.
3.  Icon (button) to access milling station parameters.
4.  Icon (button) to access glue station features.
5.  Icon (button) to access to nipping functions.
6.  Icon (button) to access to set up parameters.
7.  Icon (button) for cleaner cycle or glue cycle.
8.  Icon (button) to access to alarms window,  if the icon has a red background you have alarms or warnings on.
9.  Icon (button) set the speed of the machine (depending on the thickness of the book).
10.  Icon (button) to set up nipping time.
11.  Icon (button) for book counter, (ex 0 on right side of the icon highlighted with “1” on the drawing , shows you the produced copies, left side of the icon highlighted with “2” on the drawing to visualize different kinds of counters).

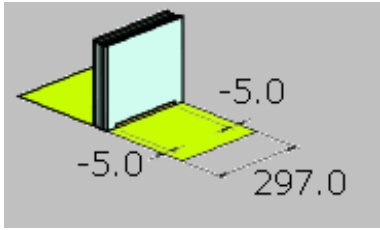

- 12. Icon (button) you can set up the frontal and rear stop gluing, and book length selecting the dimensions. If you press on sketch you have the possibility to change working function.

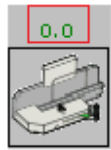

- 13. The number above the clamp indicates the possible shift between book and cover (value not modifiable).

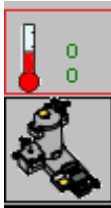

- 14. The numbers above the glue station (value not modifiable) indicate the current temperature of the glue pot and the nozzle. If the thermometer is red, the gluing station is not ready, if green it is ready to glue.



- 15. Status indicator for sensors, date and time.

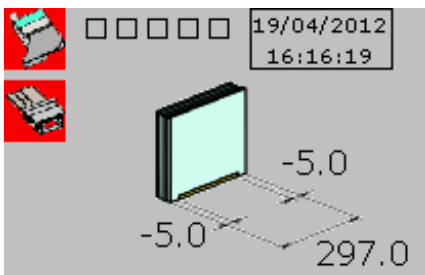

- 16. Red icons (not activated) indicate an eventual off status for the milling and nipping station.

Buttons functioning.

Following the previous buttons numbering let's see their functions.

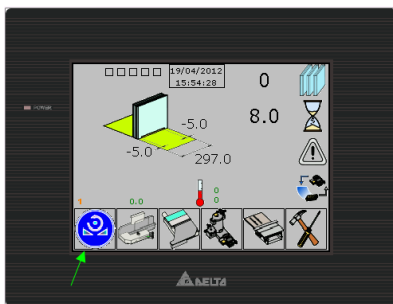

- 1. In order to do the preset you have to press the icon (green arrow). This will start to blink. Press the frontal buttons and hold them until the procedure is over. At this time the icon will disappear.

2. Icon button for carriage parameters. Once the icon is pressed, the window below will appear

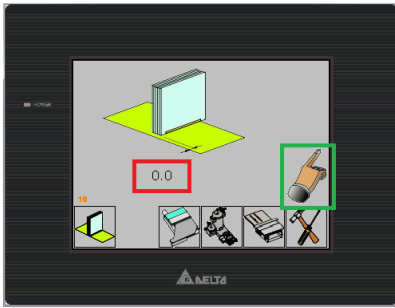

The value in the red box can be modified from -10mm to +10mm. This moves forward (positive sign) or backward (negative sign) the carriage (and consequently the book on the cover) during the cycle. As a result the cover can stick out or stick in from the book.

Pressing on the hand in green box, you access to windows for manual movements for the carriage (see below).

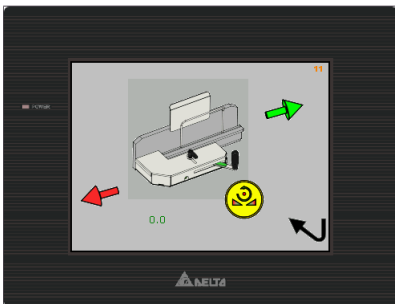

In order to make forward and backward movements or carriage preset, it is necessary to select the direction (below the selection made a green checkmark will appear) and press together the two buttons on the front part of the machine until the desired position. The number below the clamp indicates the current position for the carriage.

3. Icon, milling station button. Once the icon is pressed, the window below will appear.



Here you can decide if you want to run the milling station or not during the cycle (if the, milling disk option is present, is not possible disable it). The checkmark moves to indicate the selection you have made. The central icon activates the manual vacuum. When the milling station is off, on the main window the selection is indicated by a red icon (see the image below).

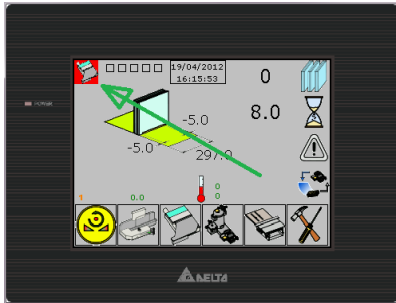

4. Icon, glue station button. When the icon is pressed, the window below will appear.

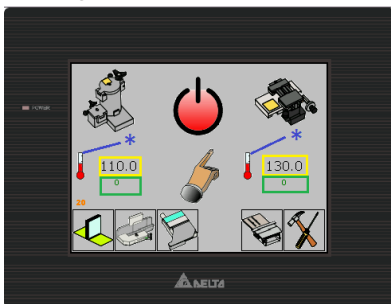

The number in the yellow box is the desired value of temperature, that one in the green box is the current value of the temperature. The indicators with “ * ” will be **red** if the temperature is out of threshold of tolerance, **green** if they are in. Current fixed threshold (-2°C +5°C).

The button on the center of the windows (red one) put the machine in stand-by without waiting for the stand by timer set up on 1800 Sec.

Pressing on the hand, you access to windows for manual movements for the nozzle (see below).

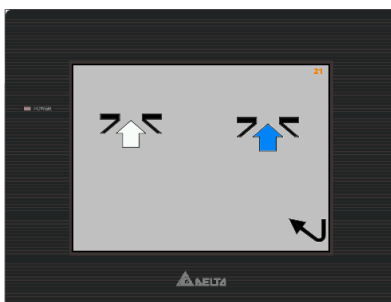

The temperatures must be set up according to the kind of glue you are going to use, please refer to the temperatures suggested by the glue producer.

The premelter temperature must be 5° to 15°C lower compared to that one of the extruder. During the heating phase the indicators will be red and the machine will highlight the message “Temperature not OK “.

When the detected temperatures will correspond to the set ones, the indicators will be green; at this time the machine will wait for a timer expectant for temperature stabilization. At the end of this process the machine will be ready for use.

The standby decreases the temperatures of 30°C to avoid unnecessary continuous heating for the glue. After 30 minutes from the last book produced, the machine goes automatically in standby status. To exit the standby status, press any point on display.

You have to wait for the glue to reach the predetermined temperature.

When the correct temperature is reached, it will be possible to position the axis and produce books.

Icon (button) “hand” open the page of the manual functioning for glue station, see image below

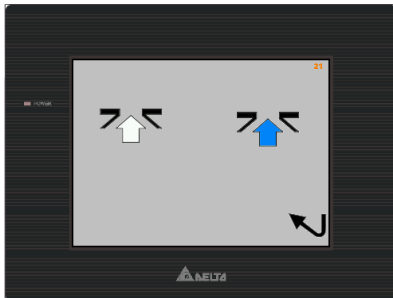

Multifunctional button with white arrow for glue spillage:

- Keeping pressed the button less than 1 sec you open and automatically close the glue valve.
- Keeping pressed the button less than 2 sec but more than 1 sec, you open and automatically close the glue valve filling and putting under pressure the glue tank. This pressure is maintained for 10 sec.
- Holding the button more than 2 sec, you open and automatically close the glue valve putting under pressure the glue tank and the glue comes out from the nozzle until you hold the button.

Button with blue arrow is the command to open the cleaner valve. The cleaner valve is open until you hold the button.

5. Icon, nipping station. Once the icon is pressed, the window below will appear.

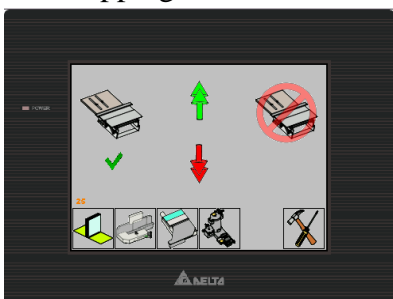

Here you can decide if you want to run the nipping station or not during the cycle. The checkmark moves to indicate the selection you have made. The double green arrow makes the nipping station to go up until you hold it. The double red arrow makes the nipping station to go down without holding.

When the nipping station is off, on the main window the selection is indicated by a red icon (see the image below). The book icon changes when the nipping station is off. In this status you have the possibility to make book block.

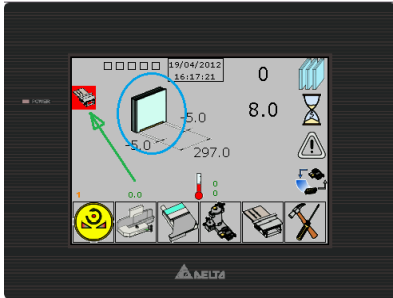

6. Icon, service button. Once the icon is pressed, the window below will appear.



Possibility to choose language, date and time, contrast and brightness for the display, access to technical service area using a password.

7. Icon, cleaner and glue cycle button. When the icon is pressed more than 1 sec, the window below will appear

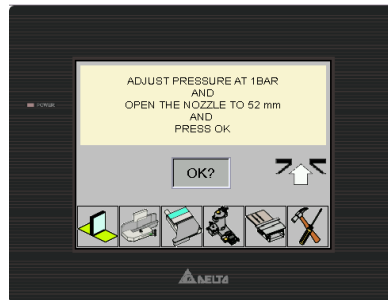
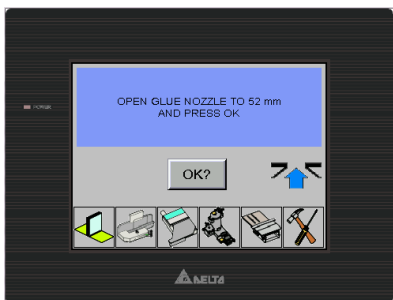

Follow the instructions on display to execute the cycle, pressing the blue or white arrows icons you make the fluid to go out if that one that has been set up is not enough. To go out without finishing, press whichever icons below you want.

See chapters 12-13.

8. Icon, alarms button. When the icon is pressed, the window below will appear.

MyBinding.com
 5500 NE Moore Court
 Hillsboro, OR 97124
 Toll Free: 1-800-944-4573
 Local: 503-640-5920

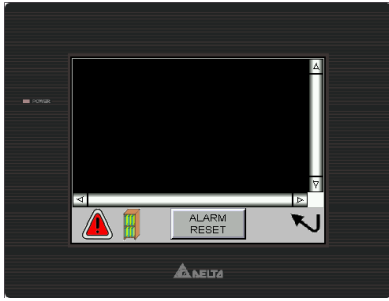

Here you have the active alarms, press ALARM RESET to reset the resettable alarms. With



this icon you access the window for alarms record.

N°	Warnings	Description
A01	<i>Air pressure insufficient</i>	<i>Air pressure fault to the machine. Verify that the manometer at the entry is at 6 bar or that the compressor is suitable</i>
A02	<i>Emergency activated</i>	<i>The emergency stop button is pressed or one of the doors is open.</i>
A03	<i>Error movement carriage</i>	
A04	<i>Allarm inverter</i>	<i>Reset the alarm if it does not reset Reboot the machine waiting for 2min. If the problem persists, contact technical support.</i>
A05	<i>Error relay press</i>	<i>Reset the alarm if the problem persists, contact technical support.</i>
A06	<i>Error movement press</i>	<i>The press has not achieved the position in the specified time. Check it's movement.</i>
A07	<i>Error relay heating</i>	<i>Reset the alarm if the problem persists, contact technical support.</i>
A08	<i>Error milling station supply</i>	<i>Check the fuse FU13.01</i>
A09	<i>Cleaner present</i>	<i>At shutdown of the machine the head cleaning has been made with the automatic cycle of the cleaner. Use the loading glue cycle, load the glue. The machine with this alarm does not work.</i>
A10	<i>Temperatures not OK</i>	<i>The nozzle or the premelter are not within the tolerances set. (+5 ° C -2 ° C)</i>
A11	<i>Execute preset</i>	<i>The carriage or the nipping station need to perform preset. Press before the icon of the presets, in main page, then the two front buttons.</i>
A12	<i>Alarm hight temperature</i>	<i>Wait for 5 minutes. If after that time the temperature has dropped, making cycle cleaner and switch off the machine. Call technical support.</i>
A13	<i>Emergency button pressed</i>	
A14	<i>Rear door opened</i>	
A15	<i>Upper door opened</i>	
A16	<i>Open clamp</i>	
A17	<i>Close clamp</i>	

<i>A18</i>	<i>Cover not present</i>	
<i>A19</i>	CRITICAL TEMPERATURE	<i>You do cycle cleaner and switch off the machine. Call technical support.</i>

9. Described before.

10. Described before.

11. Icon, copies counter button, value not modifiable. When the icon is pressed, the window below will appear.

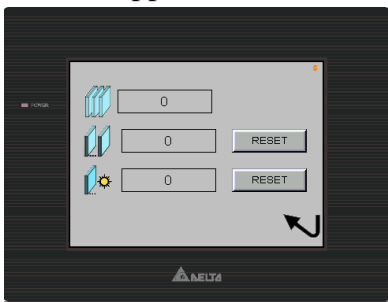

You can select the kind of counter to be visualized on the main window. Press the correspondent icon:



Total counter, not resettable.



Partial counter, resettable with a dedicated button.



Daily counter, resettable with a dedicated button.

When you have selected the kind of counter to be visualized on the main window, the icon too changes in order to indicate it.

12. Icon, kind and dimension for the book button. When the icon is pressed, the window below will appear.

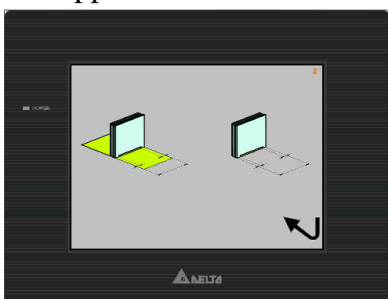

MyBinding.com
 5500 NE Moore Court
 Hillsboro, OR 97124
 Toll Free: 1-800-944-4573
 Local: 503-640-5920

Selecting the left icon you will produce book with cover, selecting the right icon you will produce book block. In this case too the icon on the main window will change to indicate the typology of work you are doing. When you select the right icon, you make the nipping station off.

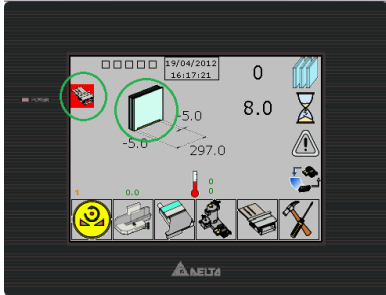

13. The number above the clamp indicates the value you have set up at point 2.

14. The indicator “thermometer” above the glue station group is red until when the pre-melter and the nozzle have reached the working temperature and the temperature inside is stabilized by a timer. When everything is stabilized the indicator “thermometer” is green. Until when the indicator “thermometer” is red, it is not possible to make glue and cleaner cycle.

15. Indicators for sensors,

- first box is green if the carriage preset sensor is on
- second box is green if the “closed clamp” sensor is on when you have the carriage in the initial position
- third box is green if the “closed clamp” sensor is on when the carriage is on the nipping station
- fourth box is green if the nipping station is down
- fifth box is green if the nipping station is up

16. See above at point 15.

- first ring glows green if the preset sensor is energized
- second ring glows green if the sensor for closed clamp is energized
- third ring glows green if the sensor for closed clamp with carriage on the press is energized
- fourth ring glows green if the sensor for press in position “bottom” is energized
- fifth ring glows green if the sensor for press in position “up” is energized
- sixth ring glows green if the sensor for cover presence is energized

17. Previously described.



MyBinding.com
5500 NE Moore Court
Hillsboro, OR 97124
Toll Free: 1-800-944-4573
Local: 503-640-5920

12 PREPARATION OF THE MACHINE TO PRODUCE A BOOK.

12.1 GLUE REFURBISHMENT PROCEDURE

The glue refurbishment procedure must be done every time the machine is switched off with the procedure END OF JOB.

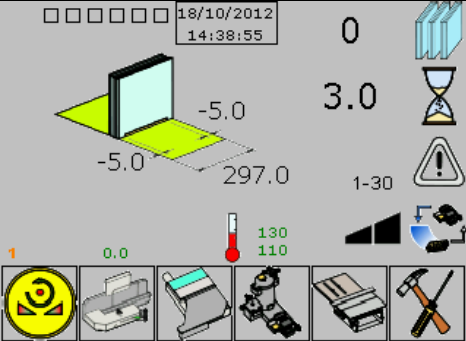
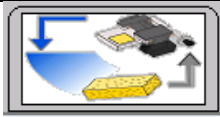
In case the machine has been switched off with the END OF JOB procedure, it will be possible to start working only doing a glue refurbishment. An error message appears “**Machine with Cleaner**”.

	<p>Primary condition: machine in temperature tank valve open in vertical position</p>
	<p>Hold the button  for few seconds to start the GLUE REFURBISHMENT procedure</p>
	<p>Follow step by step the instructions on display.</p>
<p>Adjust the manometer for glue pressure as indicated (1 bar).</p>	

Remove the grub screws using the allen key you have (pay attention to the temperature).

Press the key "OK"

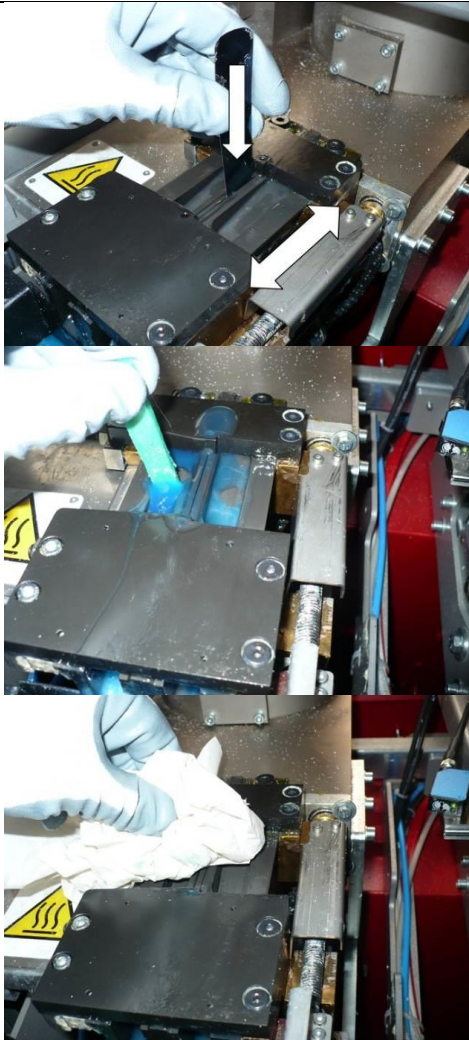
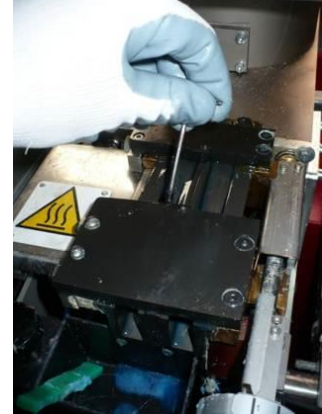

Press the button  until the traces of Blue cleaner disappears.

Help the glue to exit from the bin by using the green spatula.

Help themselves with the fin calibrated in this operation.

Clean carefully all the excess spillage using the spatula and paper towels

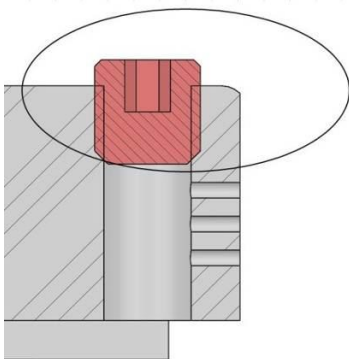

Replace the headless screws using the L-wrench provided (beware of temperature), press **OK**.

Attention! Headless screws max. protrude 1 mm

Now the machine is ready to work.

13 COVER POSITIONING

	<p>The indicator “A” marks the position of the cover register “B”.</p>
	<p>The value “A” indicated indicates is the same as the X dimension.</p>
	<p>Position the cover manually as shown by the arrows, against the eccentrics indicated on the side and against the cover register “B”, see previous picture.</p>

MyBinding.com
 5500 NE Moore Court
 Hillsboro, OR 97124
 Toll Free: 1-800-944-4573
 Local: 503-640-5920



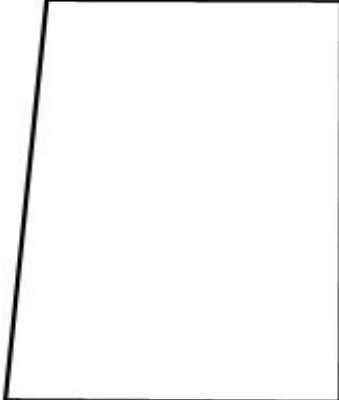
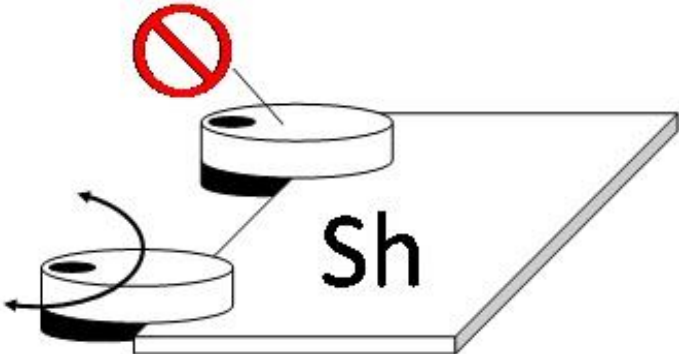

The standard calibration requires that the angle between the sides of the cover is 90 °

	<p>The standard calibration requires that the angle between the sides of the cover is 90 °.</p>
	<p>If the cover has some problems caused by improper trimming, you can adjust the placement by adjusting the position of the eccentric on the operator side.</p>
	

Preparation of the machine to manufacture a book.

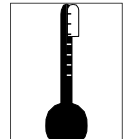

CONTROLS TO PERFORM BEFORE STARTING THE JOB

Before to use the Perfect Binder perform the following controls:

	The operator must have read and understood this manual, including the important information concerning the SAFETY.
	Make sure you have appropriate clothing to work and, if necessary, also safety clothing.
	Ensure that the Master Book is properly powered and connected to ground (PE)
	Ensure that the pneumatic system of the Master Book is properly fed and if the main switch oh the factory is open.
	Verify that the chips aspirator is connected to the Master Book and its power switch is in position 1 = ON.
	Check that in the tank there is a minimal amount of glue to allow manufacturing several books, otherwise insert a new cartridge of glue inside the tank.
	Glue collection tank flushed.
	Ensure that the Master Book is clean and without books or covers, especially: Clamp, Silent Plate, Milling Station, PUR head, Press.
	Check that the temperature settings are correct for the used glue and that have been achieved the correct values to work. Refer to the technical sheets of the glue/cleaner manufacturer.
	Verify that the values of temperatures have reached their work values. Both temperature indicators must be lit.
	If necessary, remove the layer of Blue-Cleaner from the PUR head.

MyBinding.com
 5500 NE Moore Court
 Hillsboro, OR 97124
 Toll Free: 1-800-944-4573
 Local: 503-640-5920

13.1 STARTING THE MACHINE

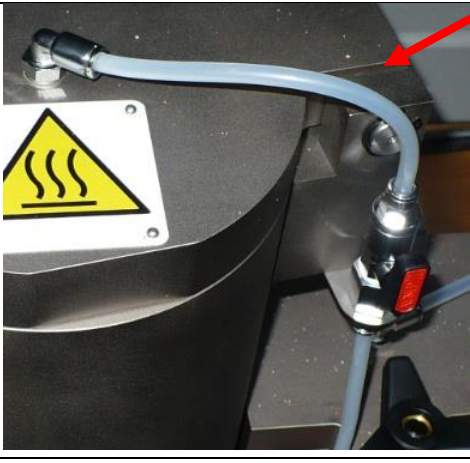
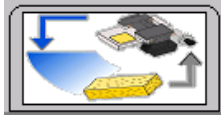
01		<p>Machine ignition using the main switch. Take the switch in ON position.</p>
02		<p>Verify if the pressure indicated in the entry manometer is correct. MIN 6 BAR</p>
03		<p>Open the valve on the premelter. The valve with the lever in vertical position means that is open.</p>
04		<p>Verify the selected temperatures</p>
05		<p>Wait for heating phase.</p>
06	<p>Press the key</p> 	<p>Do the glue recovering procedure. At the end of the glue recovering process the machine performs a series of closing/opening cycles of the glue valve.</p>
07		<p>Digit the parameters for front, back and book length glue stops.</p>
08		<p>Select the desired speed</p>

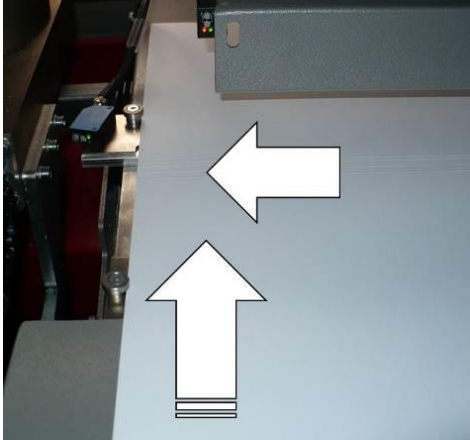
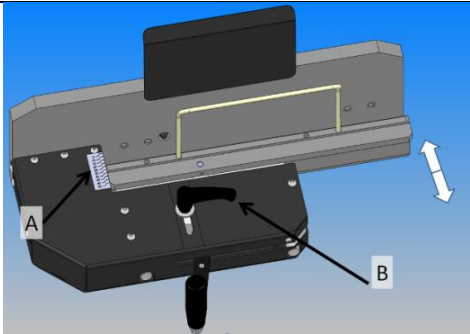
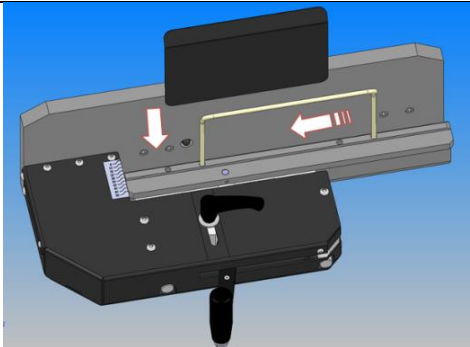
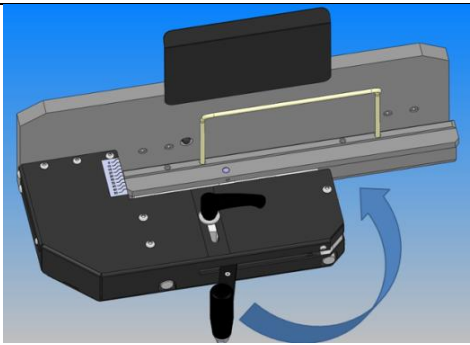
09		Do a general reset
10		Adjust the glue pressure
11		Put the cover onto the press leaning it against the left fix datum and that one adjustable at the end of the press.
12		Adjust the thickness of the book loosening the knob B, then move the front jaw until the measure of the book thickness you read on tag A. Turn the knob B.
13		Load the fascicle in the clamp as indicated from the arrows in the image.
14		Close the clamp as indicated.

MyBinding.com
 5500 NE Moore Court
 Hillsboro, OR 97124
 Toll Free: 1-800-944-4573
 Local: 503-640-5920

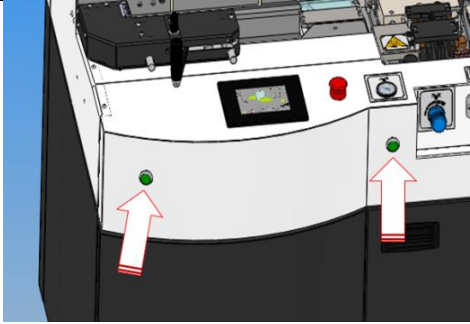
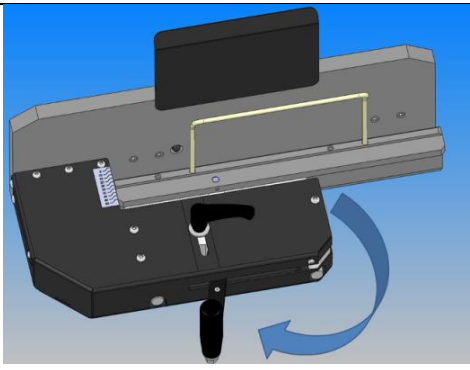
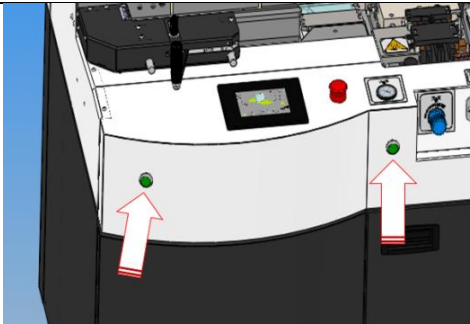
15		<p>Press together the two keys on the front side of the machine.</p>
16		<p>The machine will start working on the book; the clamp will move passing onto the milling disc and onto the glue station, when it will reach the position, the press will put the cover.</p>
17		<p>Open the clamp.</p>
17		<p>Press together the two keys on the front side of the machine.</p>
17		<p>The clamp will return to the loading position. Take away the book from the press and repeat all the points from 11 if you want to produce a book with the same characteristics.</p>

MyBinding.com
 5500 NE Moore Court
 Hillsboro, OR 97124
 Toll Free: 1-800-944-4573
 Local: 503-640-5920

14 BOOK SPINE PREPERATION

14.1PREPERATION OF LARGER BOOKS

When making books larger than 30mm in width its not reccomended to use both cutting tools.



The use of protective gloves is recommended during this procedure.



<p>Use a 5mm L-Wrench turn turn the milling disc clockwise into the required position.</p>	
<p>Remove the notching tool screw.</p>	
<p>Insert the supplied M6 x 30 screw into the vacant hole and then extract the notching tool..</p>	
<p>Turn the tool 180 degrees and replace so that the cutting side is inside the milling head.</p>	

This operation balances the cutter for better spine preperation of larger books.



Reverse the procedure when using books smaller than 31mm.

MyBinding.com
5500 NE Moore Court
Hillsboro, OR 97124
Toll Free: 1-800-944-4573
Local: 503-640-5920

14.2 CHANGING THE NOTCHING TOOL HEIGHT.

The height of the notching tools can be decreased by removing a spacer situated underneath each tool. To do this follow the steps below.



The use of protective gloves is recommended during this procedure.

<p>Use a 5mm L-Wrench turn the milling disc clockwise into the required position.</p>	
<p>Remove the notching tool screw.</p>	
<p>Insert the supplied M6 x 30 screw into the vacant hole and then extract the notching tool. Remove the spacer underneath and refit the tool.</p>	
<p>Repeat for the 2nd tool.</p>	

MyBinding.com
 5500 NE Moore Court
 Hillsboro, OR 97124
 Toll Free: 1-800-944-4573
 Local: 503-640-5920

15 CLEANING THE MACHINE

When the machine work using PUR glue, it is imperative and essential an accurate cleaning of the glue.

The dried glue is no more refundable.

Residue of glue during the drying process can cause blockages or a uneven extrusion of the glue.

The glue group must be kept clean with the deposits of glue, PUR glue residues harden over time and cause damages to the equipment.

Performing the “End of job cleaning” it is possible to save the machine turned off containing PUR glue for 2 weeks.

COMPULSORY CLEANING for proper operation of the machine.

"If the machine is **switched off or unused for more than 120 minutes**, it is necessary to make the cycle of "End of job cleaning".

EVERY DAY:

END OF JOB CLEANING

ONCE IN THE WHEEK:

EMPTY THE CHIPS ASPIRATOR

CLEANING SIDE EXTRUDER

CLEANING SPINE EXTRUDER

CLEANING DETAILS

In case of:

Some pages are not glued	Perform the spine extruder cleaning
The glue on the side is not uniform	Perform the side extruder cleaning

MyBinding.com
 5500 NE Moore Court
 Hillsboro, OR 97124
 Toll Free: 1-800-944-4573
 Local: 503-640-5920

15.1 “END OF JOB” CLEANING

 <p>The screenshot shows a control panel with a date and time display (18/10/2012, 14:38:55), a speed indicator (0), a pressure indicator (3.0), and a temperature gauge (130, 110). There are several icons for different machine functions and a warning symbol.</p>	<p>To switch off the machine at the end of the day you must eject the remaining glue inside of the extruder.</p> <p>To do it you must activate the automatic procedure that allows executing a safety off.</p> <p>Hold for a few seconds the button  to start the procedure.</p>
 <p>The top part of the screenshot shows a display with the text: "OPEN GLUE NOZZLE TO 52 mm AND PRESS OK". Below the text is an "OK?" button and a blue arrow icon. The bottom part of the screenshot shows a hand in a white glove using a black spatula to clean the extruder nozzle.</p>	<p>During this phase the glue group prepares for daily cleaning. Follow step by step the instruction on display.</p> <p>Use the green spatula included and make the glue flow in the collection tank. Try to remove as much as possible of the released glue.</p> <p>Press  until all the glue traces disappear. For this operation help yourself with the calibrated blade.</p> <p>Press  until from the extruder exits only cleaner.</p>
 <p>The photo shows a hand turning a red-handled valve on the back of the machine. The valve is currently in a vertical position.</p>	<p>Once the clearing process is over, close the valve on the back. The valve is closed when in horizontal position.</p>

15.2 PROCEDURE TO CLEAN THE SPINE GLUE EXTRUDER.

	<p>Press the key that corresponds to the glue station.</p>
--	--

	<p>Press the key for manual movements.</p>
--	--

	<p>Open the glue head until dimension 52. Use the small wheel indicated with "A", see below.</p>
--	--

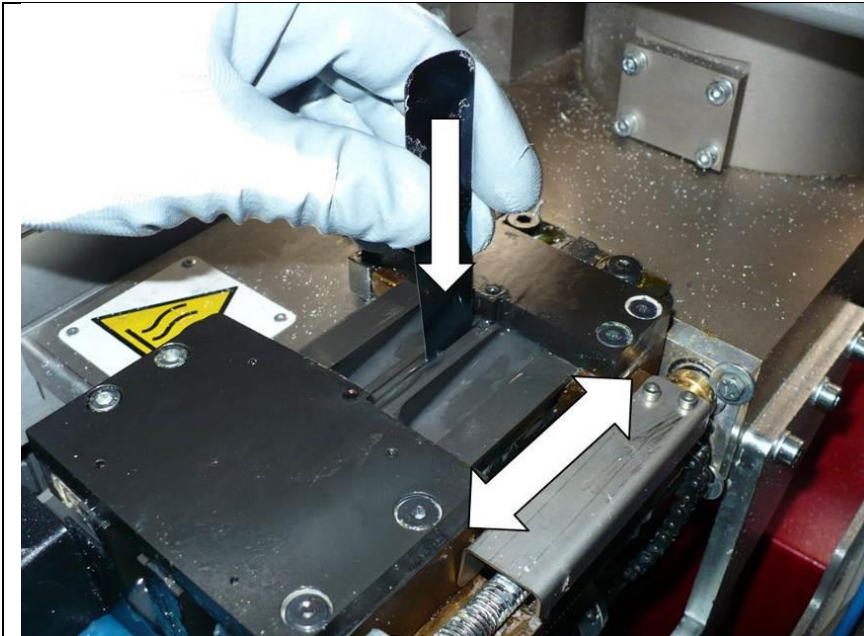

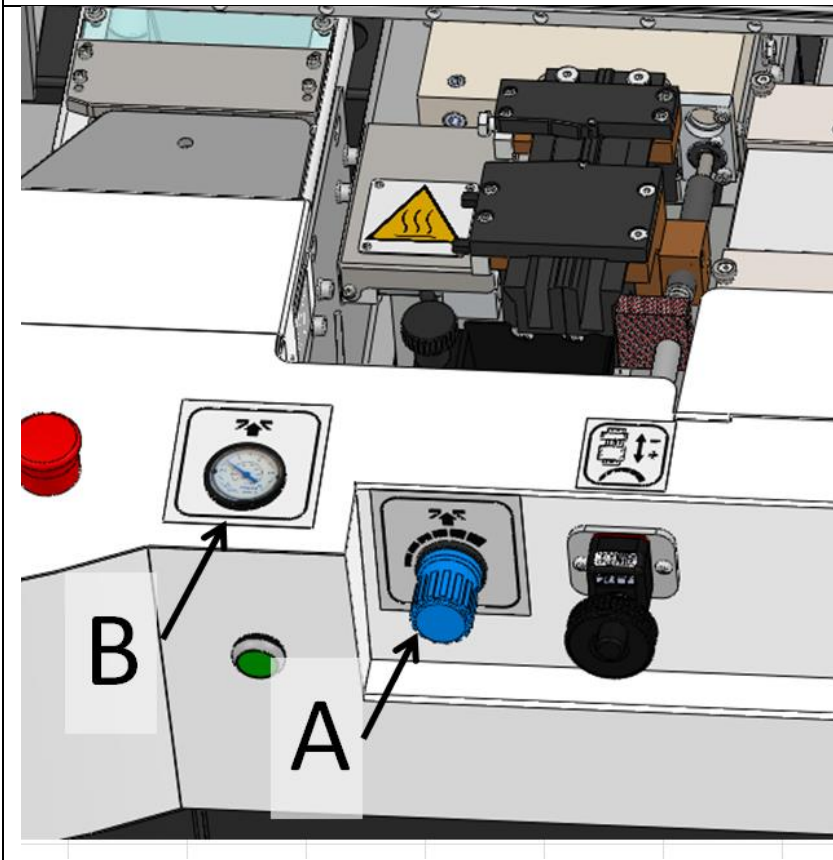

Insert the calibrated blade into the slot extrusion to touch the bottom and move it along the slot to remove or release any possible obstructions.





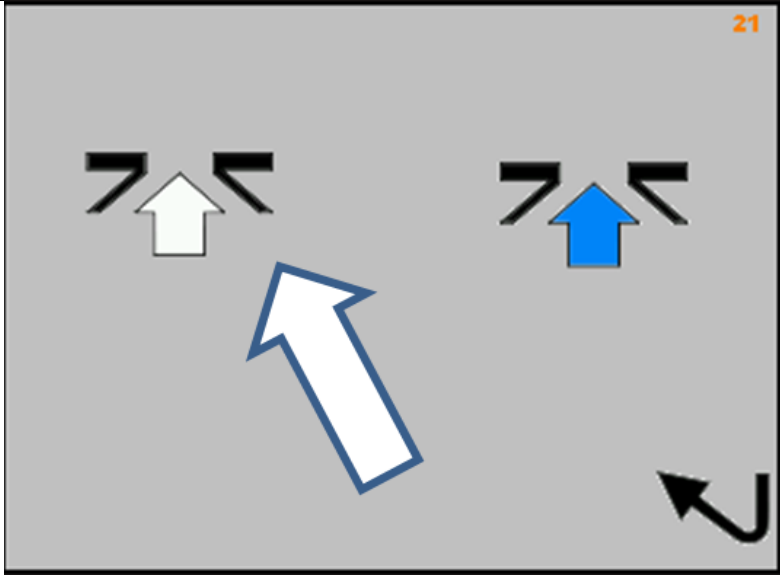

Adjust the value of the glue extrusion pressure to 1bar using the regulator “A”. This value can be read on the manometer “B”.

MyBinding.com
5500 NE Moore Court
Hillsboro, OR 97124
Toll Free: 1-800-944-4573
Local: 503-640-5920

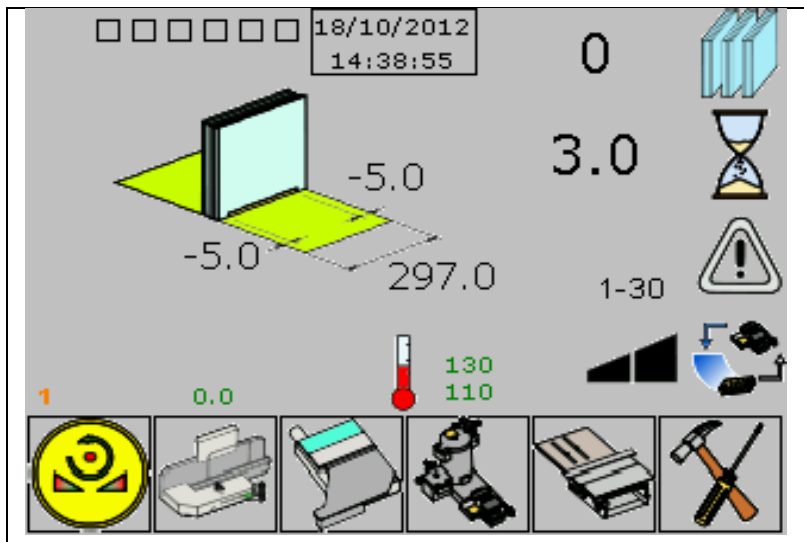
	<p>Hold the key spill glue as indicated by the arrow for few seconds until you do not see the glue spilling.</p> <p>Verify that the glue extrusion is uniform and continuous; otherwise, insert the calibrated blade and repeat the cleaning operation.</p> <p>The tank pressure will turn off after 10 sec. of inactivity.</p>
	<p>Thoroughly clean the blade. When the glue is fully cured the blade will no longer operate.</p>

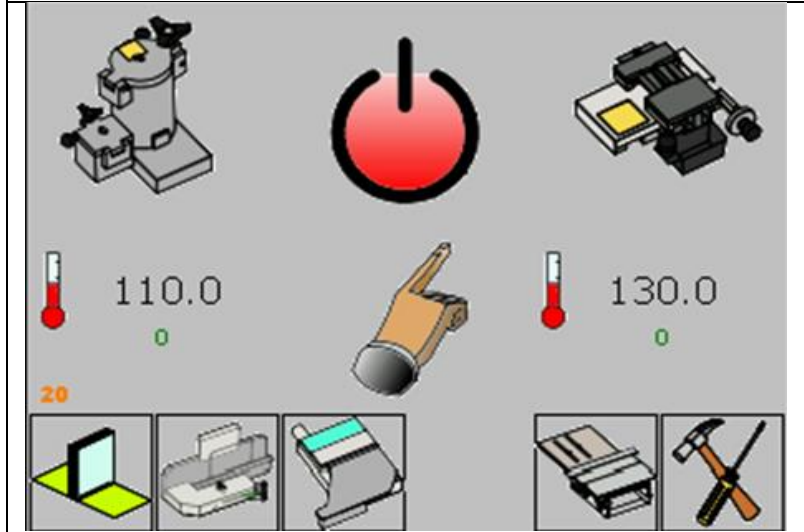
15.3PROCEDURE TO CLEAN THE GLUE SIDE EXTRUDERS.

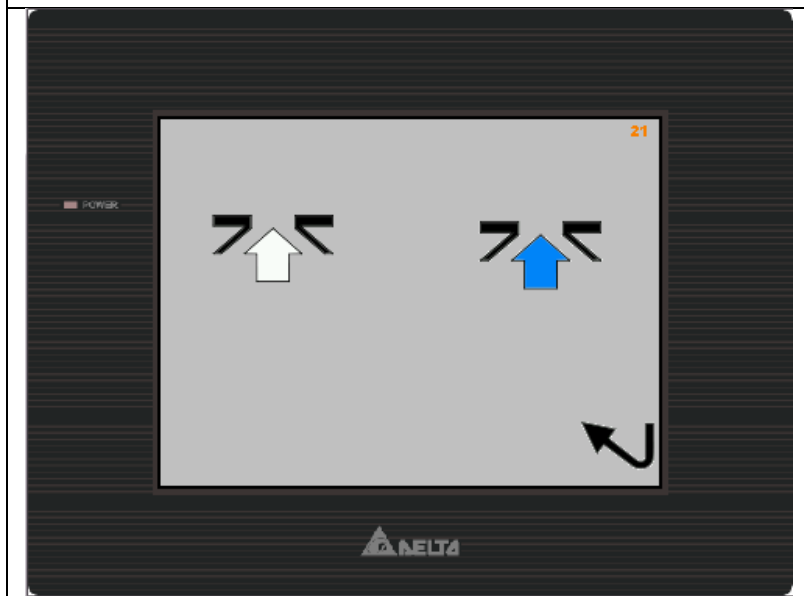
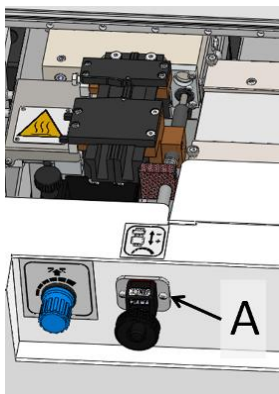
 <p>The screenshot shows a control panel with a date and time display (18/10/2012, 14:38:55), a large '0' and '3.0' display, and a 3D diagram of a glue application. Below the diagram are numerical values: -5.0, -5.0, and 297.0. There are several icons including a warning sign, a hammer and screwdriver, and a hand icon. A temperature gauge shows 130 and 110. A row of icons at the bottom includes a yellow smiley face, a glue extruder, a roller, a glue station, a roller, and a hammer and screwdriver.</p>	<p>Press the key corresponding to glue station</p> 
 <p>The screenshot shows a control panel with a power button, a hand icon, and two temperature gauges showing 110.0 and 130.0. Below the gauges is a row of icons including a glue extruder, a roller, a glue station, a roller, and a hammer and screwdriver.</p>	<p>Press the key for manual movements.</p> 
 <p>The screenshot shows a control panel with a handwheel labeled 'A' and a 'DELTA' logo at the bottom. The handwheel has a blue arrow pointing up and a black arrow pointing right.</p>	<p>Open the buttering head until quote 52. Use the Handwheel indicated by "A" see below.</p> 

MyBinding.com
5500 NE Moore Court
Hillsboro, OR 97124
Toll Free: 1-800-944-4573
Local: 503-640-5920

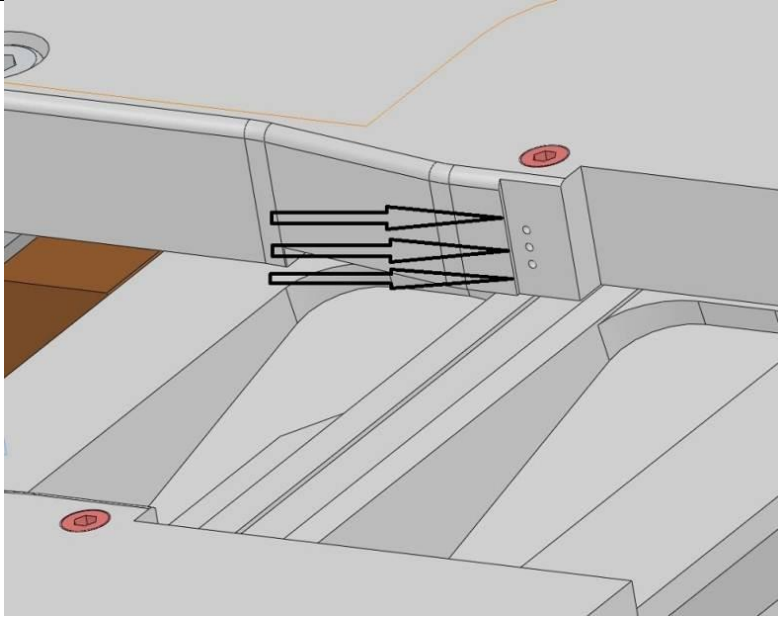

The glue smeared on the side of the book is extruded through 3 small channels located on the plates containing the book.

To get a correct extrusion of the side glue you must remove the headless screw and insert in the holes the included wire. Repeat this operation on the two plates of containment of the book.

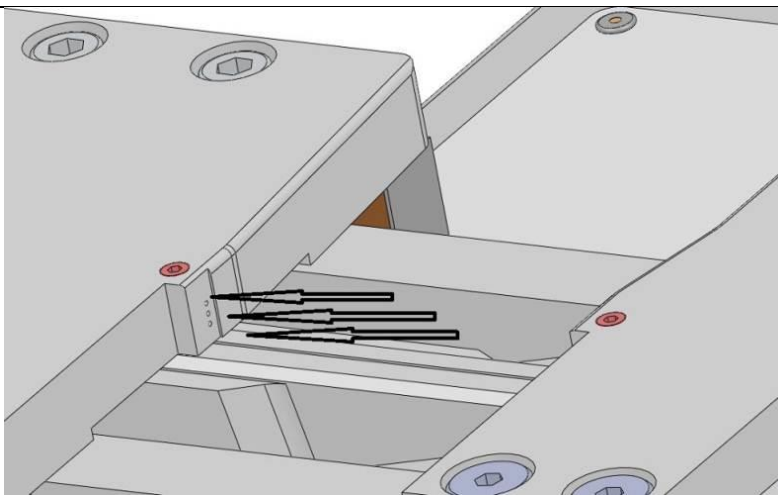
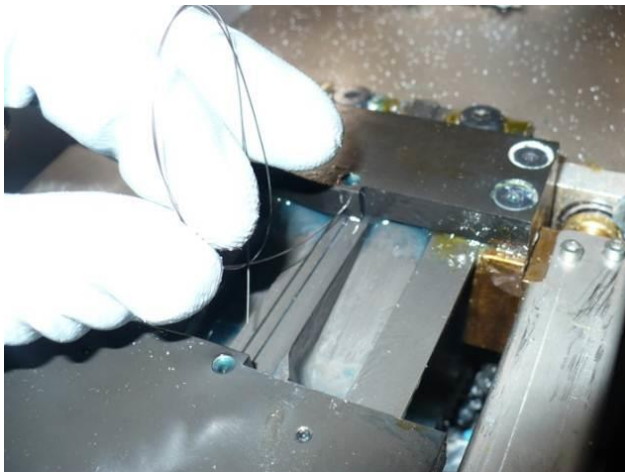

To get a correct extrusion of the side glue you must remove the headless screw and insert in the holes the included wire.

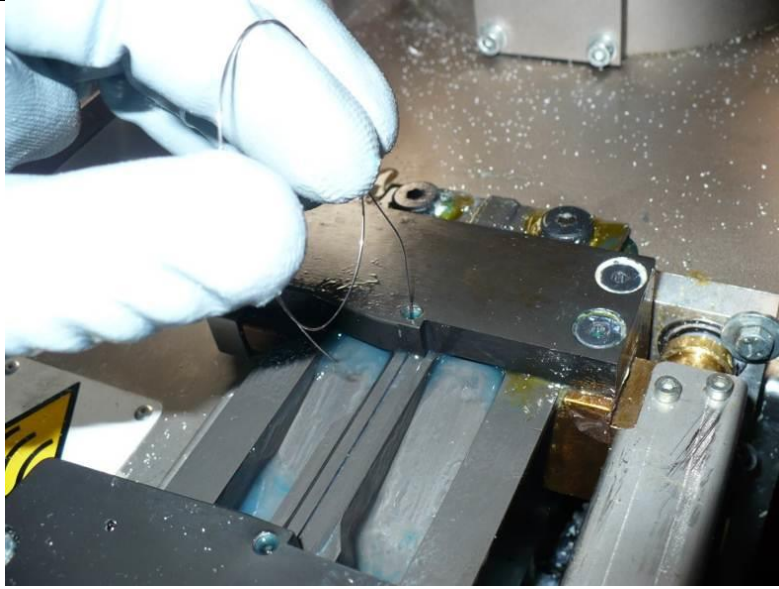

Pass the thread also in the main conduit until you enter into the below slot.

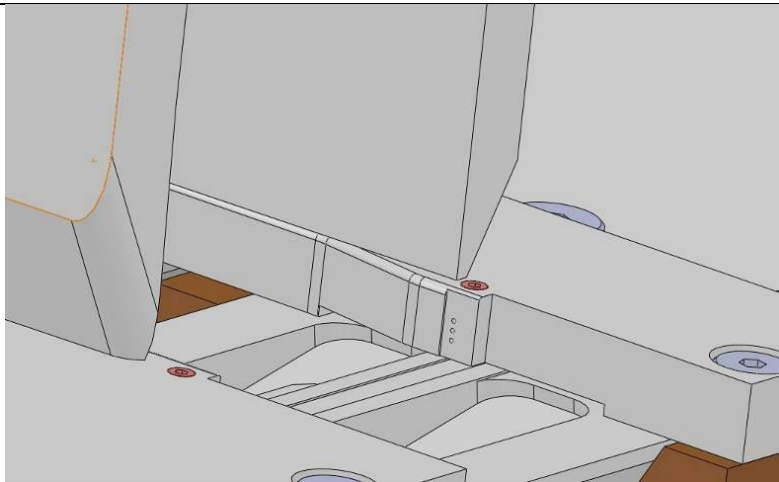
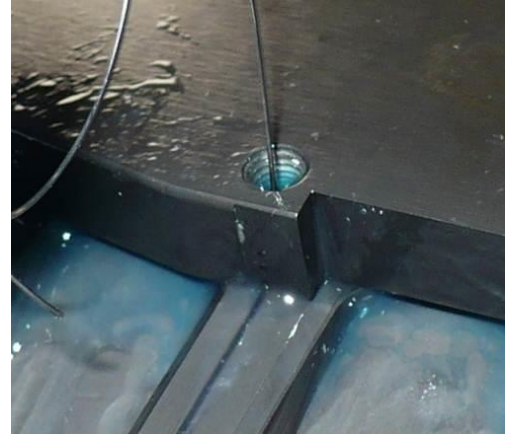

Be careful. When you replace the headless screws, they **cannot protrude** otherwise you cause a collision with the nipping station.

Attention! Headless screws max. protrude 1 mm

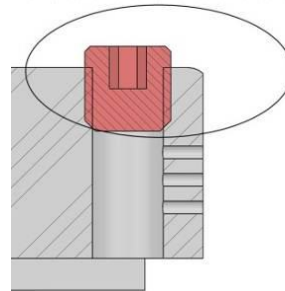

MyBinding.com
5500 NE Moore Court
Hillsboro, OR 97124
Toll Free: 1-800-944-4573
Local: 503-640-5920

15.4 DETAILS CLEANING

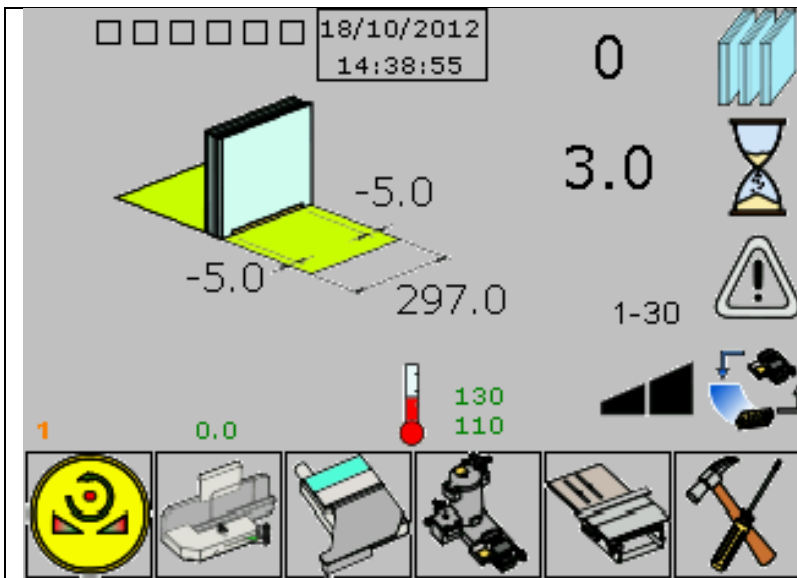

Press the key corresponding to glue station

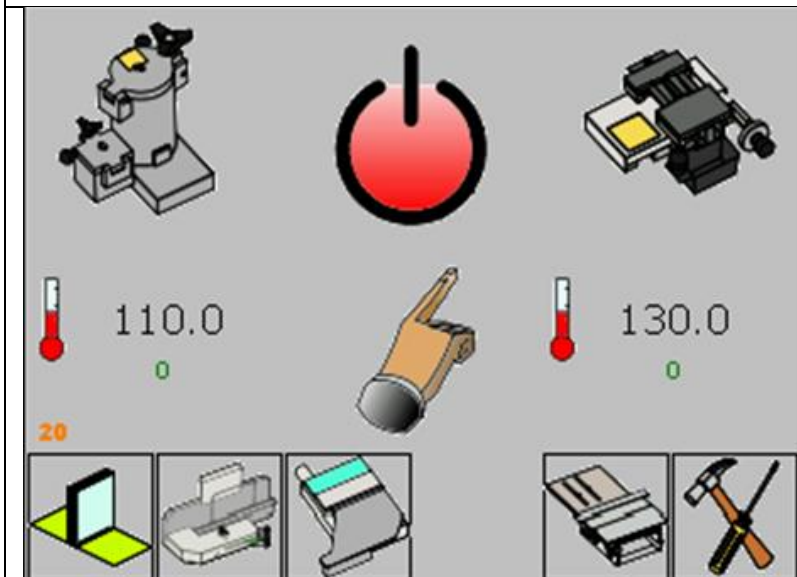
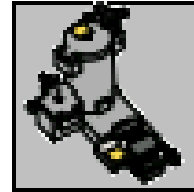

Press the key for manual movements.

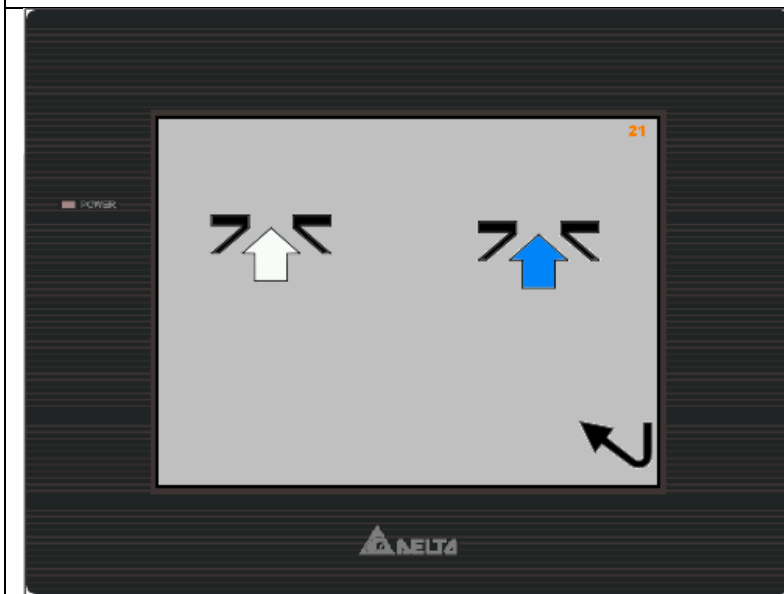

Open the buttering head until quote 52. Use the Handwheel indicated by "A" see below.

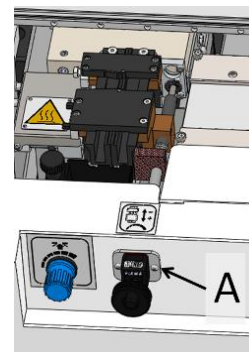

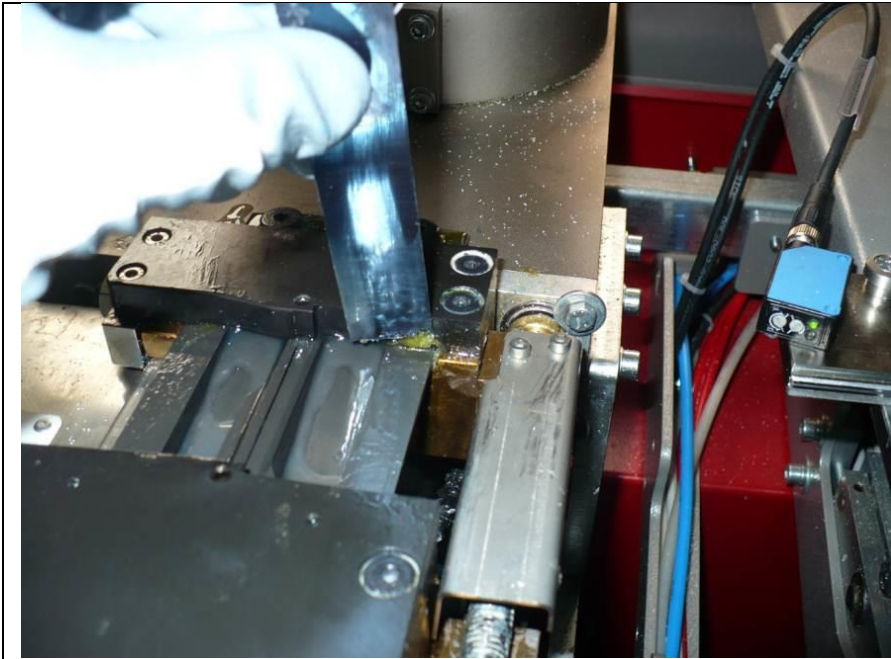

Use the included blade to remove all the visible glue traces.

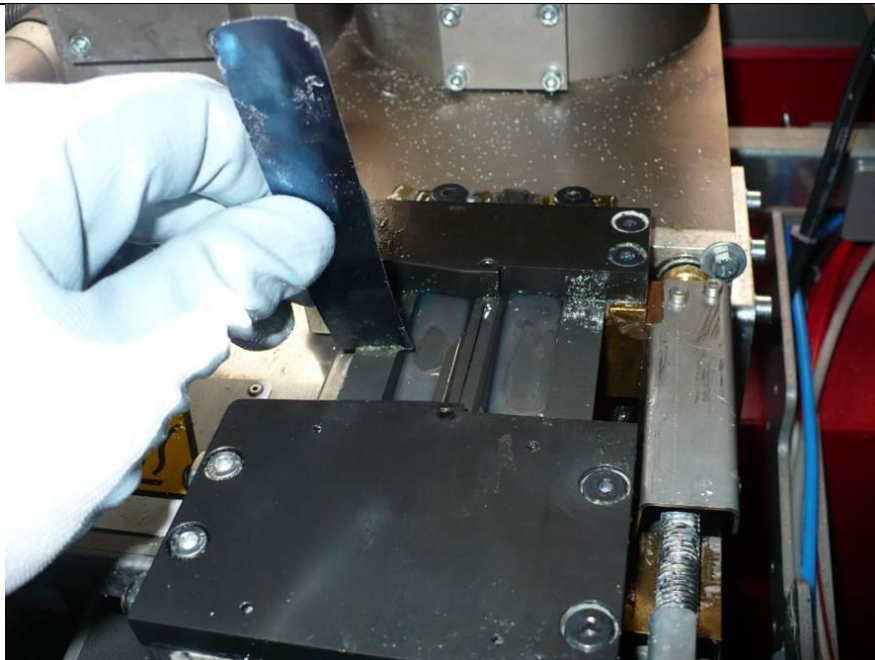

If necessary you can use liquid solvents to get a better cleaning of the surface.

During the use of liquid solvents refer to the safety instructions provided by the solvent manufacturer.



Clean carefully all the tools used, otherwise they become unusable later.

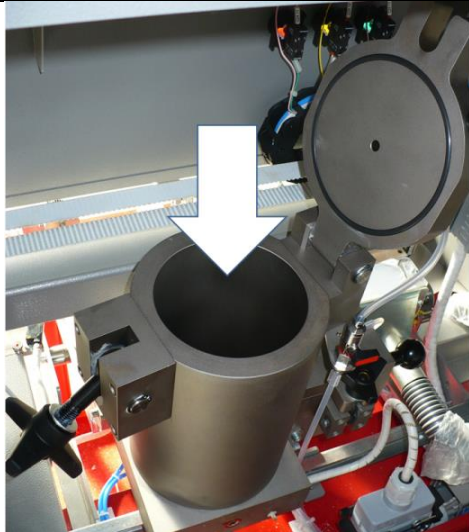

Clean periodically the glue tank. Please pay attention to **HOT TEMPERATURE**, use rags that do not leave any remain. Use scraping off tools that do not damage the internal surface of the premelter. Avoid that parts of cured glue remain inside the premelter. These would occlude the nozzle. If the premelter is too dirty or crusted, please call the assistance to wash it with proper solvents.

MyBinding.com
 5500 NE Moore Court
 Hillsboro, OR 97124
 Toll Free: 1-800-944-4573
 Local: 503-640-5920

16 Problems - Solutions

16.1 CHIPS ASPIRATOR – LESS VACUUM:

- Verify that the Plexiglas inspection, located on the Milling Station, is free.
- Verify that the chips aspirator tank is empty.
- Verify that the chips aspirator tube is not full of chips.
- Verify that the aspirator filter is clean.
- Check that the hose is connected.

16.2 CLAMP – IT DOESN'T START:

- Verify the presence of a book.
- Verify that the emergency switch is disabled.
- Verify that the book detecting photocell and the related reflector are clean.
- Verify that the photocell or the reflector of the press is free from books, pieces of paper or dust.
- Verify that the clamp jaws are free from glue residues.
- Verify the air pressure in the machine.
- Verify that the carriage has made the zero placement the display is located on the main page?
- Verify that you are on the main page

16.3 MILLING STATION – IRREGULAR CUT AND NOTCHING:

- Verify that the Milling disk is not broken or damaged. This could happen by the management of books already bounded with glue (TO AVOID). **IF IT IS NOTICED THAT GLUE BOUNDED BOOKS HAVE BEEN MILLED: THE GUARANTEE VOIDS**

16.4 COVER PLATE MILLING STATION – IT DOESN'T OPEN / CLOSE CORRECTLY:

- Clean carefully the contact surfaces if the milling station box.

16.5 HEAD - OUT OF TOO MUCH OR LITTLE GLUE:

- Verify the air pressure of the glue group.
- Verify that the head shutter is free, using the provided blade.
- Verify that the side holes are free, using the provided steel wire.
- Verify that the injectors are working properly (they must move back and forth 3-4 mm).
- Verify the glue presence in the tank.
- Verify that the glue in the tank is not hard-glue.
- Verify that the tank valve is open.
- Verify the position of the internal lateral jaw: it must be 0.15 tenths back from the edge of the clamp.

16.6 NIPPING STATION

- Dent book, clean the surfaces with proper solvents without using abrasive products.
- Edge pinched: contact technical support.